

FORCEMAC

MOVES YOUR EARTH

CHINA OFFICE

15th floor, Building A, Logan Century, Haixiu road, Bao'an district, Shenzhen P.R.C 518101
Tel: +86 137 2346 9140

HONG KONG OFFICE

8/F., Success Commercial Building, 245-251 Hennessy Road, Wanchai, Hong Kong
Tel: +852 3196 3233

MIAMI OFFICE

2792 NW 24 ST Miami, FL. 33142 Suite #8
Tel: +1 786 636-8264

E-mail: sales@forcemac.com
Website: www.forcemac.com

REPLACEMENT PARTS FOR HEAVY EQUIPMENT



ABOUT US

Forcemac offers its customers heavy construction machinery spare parts. Forcemac specializes to manufacture 4 Major Groups of Spare Parts; Ground Engaging Tools (GET), Undercarriage Parts, Buckets and Hardware.

We manufacture and design Ground Engagement Tools and Undercarriage Parts with latest technology. As any other product, we provide to our customers Quality Control systems in order to catch strict measurements. Forcemac offers full range of GET & Undercarriage Parts such as; Bucket Teeth, Cutting Edges, Track Roller, Top Roller, Sprocket, Idler, Track Chain & Shoes, Track Link for various types of excavator and bulldozers. Our engineers make sure our customers receive the most effective products with perfect sizing.

Forcemac is also one of the world's largest independent distributors of heavy machinery parts and diesel engine components. Our products are used for excavators, bulldozers, wheel loaders, motor graders, trucks, trailers, power generation sets and marine engines. The machine brands that Group's products support include Caterpillar, Komatsu, Cummins, Volvo, Isuzu Hitachi, Kobelco, Sumitomo, Luigong, XCMG.

The company's strong point is quality. Forcemac parts are perfectly interchangeable with the genuine equivalents and provide the highest guarantees of strength and durability. Constant striving for exceptional production standards has allowed it to obtain undisputed results in terms of reliability and precision.

Forcemac offers reliable and dedicated products that provide consistent value to buyers. Businesses can focus on their core competencies while Forcemac supplies them outstanding quality spare parts.



All manufacturer's names, numbers, symbols and descriptions are used for reference purposes only. All trademarks and registered trademarks mentioned are the property of their respective owners. All spare parts listed are interchangeable with genuine ones.



ENGINE COMPONENTS

- > Cylinder Heads
- > Liners
- > Camshafts
- > Pistons
- > Turbochargers
- > Crankshaft
- > Connecting Rods
- > Supports
- > Valves



ELECTRICAL SYSTEM

- > Lights
- > Sensors
- > Batteries
- > Switches
- > Alternators
- > Starting Motors
- > Cables
- > Solenoids



HYDRAULIC SYSTEM

- > Tubes
- > Gear Pumps
- > Vane Pumps
- > Pistons Pumps
- > Hydraulic valves
- > Hydraulic Cylinders
- > Hoses and Couplings



COOLING SYSTEM

- > Fans
- > Radiators
- > Oil Coolers
- > Elbows
- > Thermostats
- > Conveyor
- > Radiator and Heater Hoses
- > Pipes



HARDWARE

- > Bolts
- > Nuts
- > Pins
- > Studs
- > Rivets
- > Washers
- > Locks
- > Springs



UNDERCARRIAGE

- > Idlers
- > Rollers
- > Sprockets
- > Links
- > Track Shoes
- > Wheels
- > Bogies
- > Springs

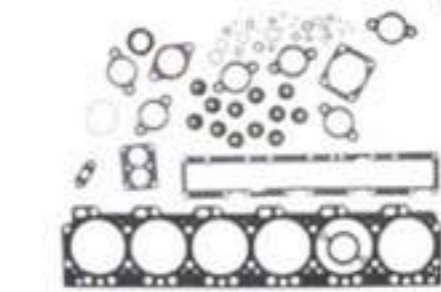

SEALS AND GASKETS

- > Engine Kits
- > O-Ring Kits
- > Hydraulic Kits
- > Gasket
- > Seals
- > Head Kit
- > Lip Seals
- > Shimps



FILTERS

- > Strainers
- > Oil Filters
- > Air Filters
- > Fuel Filters
- > Water Filters
- > Pre-cleaners
- > Service indicators



FUEL INJECTION

- > Nozzles
- > Fuel lines
- > Priming Pumps
- > Fuel Pumps
- > Lines
- > Plunger & Barrels
- > Pre-Combustion Chambers



STEERING CLUTCH & BRAKES

- > Actuators
- > Brake cylinder and camshafts
- > Discs and plates
- > Brake groups
- > Piston brakes
- > Drums
- > Cages, couplings
- > Brake pads



G.E.T. PARTS

- > End Bits
- > Bit Cutter
- > Wear Plates
- > Shank
- > Cutting Edges
- > Tips & Adapters
- > Pins & Retainers



POWER TRAIN

- > Axles
- > Yokes
- > Final drives
- > Differentials
- > Gear & Pinions
- > Universal joints
- > Torque converter



RUBBER TRACK

- ALL SIZES:
- > 180 mm
 - > 230 mm
 - > 300 mm
 - > 320 mm
 - > 400 mm
 - > 450 mm



CAB & BODY PARTS

- > Seats
- > Wipers
- > Gauges & Indicators
- > Ac Compressors
- > Mirrors
- > Alarms
- > Knobs & Handles
- > Glasses for cabin
- > Steering wheels
- > Treadle, Footboard, Platform



BEARINGS

- > Ball Bearings
- > Roller Bearings
- > Sleeve Bearings
- > Needle Bearings
- > Spherical Bearing
- > Inner and Outer Races
- > Copper & Bronze Bearings



PUMPS

- > Pumps gears
- > Pumps Metering
- > Oil pumps
- > Water pumps
- > Fuel pumps
- > Hydraulic pumps
- > Pumps Gp.Pistons
- > Barrels & Pistons



FRAME AND BODY

- > Bogies
- > Fenders
- > Wear Strips
- > Equalizer Bar
- > Track Guards
- > Track Frames
- > Shields & Covers
- > Bogies pins



PINS AND BUSHINGS

- > Pins
- > Bushings

CUMMINS & ISUZU ENGINE PARTS



Diesel Engine Models

ENGINE MODEL	CDC MODEL	NUMBER OF CYLINDERS	BORE DIAMETER mm / In
4B 3.9	4.390 Family I	4	102 / 4.016
4BT 3.9	4.390 Family I	4	102 / 4.016
4BTA 3.9	4.390 Family I	4	102 / 4.016
4BT 3.9 QSB		4	102 / 4.02
4BT 4.5 QSB		4	107 / 4.21
6B 5.9	6.590 Family I	6	102 / 4.016
6BT 5.9	6.590 Family I	6	102 / 4.016
6BTA 5.9	6.590 Family I	6	102 / 4.016
6BTA 5.9 ISB	6.590 Family I	6	102 / 4.02
6BT 5.9 QSB		6	102 / 4.02
6BT 6.7 QSB		6	107 / 4.21
6CT 8.3	6.830 Family II	6	114 / 4.484
6CTA 8.3	6.830 Family II	6	114 / 4.484

OVERHAUL KIT COMPONENTS

- Cylinder Kits or Piston Kits
- Main Bearings
- Connecting Rod Bearings
- Front Crankshaft Seal
- Rear Crankshaft Seal
- Top Gasket Set
- Bottom Gasket Set
- Piston Bushings
- Camshaft Bushing

FRACTURED OVERHAUL KIT COMPONENTS

- Cylinder Kits or Piston Kits
- Main Bearings
- Connecting Rod Bearings
- Lower Connecting Rod Bearings
- Front Crankshaft Seal
- Rear Crankshaft Seal
- Top Gasket Set
- Bottom Gasket Set
- Piston Bushings
- Camshaft Bushing

ENGINE MODEL	COMMENTS
4BT 3.9	8 Valves Piston 7163 Grade A
4BTA 3.9	8 Valves Piston 7156 Grade A
4B 3.9	8 Valves Piston 6223 Grade A
4BT 3.9	8 Valves Piston 6632 Grade A
4BTA 3.9	8 Valves Piston 9041 Grade A
4BTA 3.9	8 Valves Piston 8673 Grade A
4BT 3.9	8 Valves Piston 0187 Grade A
6BT 5.9	12 Valves Piston 7163 Grade A
6BTA 5.9	12 Valves Piston 7156 Grade A
6B 5.9	12 Valves Piston 6223 Grade A
6BT 5.9	12 Valves Piston 1400 Grade A
6BT 5.9	12 Valves Piston 6632 Grade A
6BTA 5.9	12 Valves Piston 2571 Grade A
6BTA 5.9	12 Valves Piston 7619 Grade A
6BTA 5.9	12 Valves Piston 9041 Grade A
6BTA 5.9	12 Valves Piston 8673 Grade A

Eng. O/H & I/F Kit	1) Piston Kit	Main Bearing Set	Con Rod Bearing
COK2160/4 Std.	2) Repair Sleeve	C3802010 Std.	C3901170 Std.
COK2132/4 0.50 mm	1) C3802160 Std.	C3802011 0.25 mm	C3901171 0.25 mm
COK2134/4 1.00 mm	C3802132 0.50 mm	C3802012 0.50 mm	C3901172 0.50 mm
	C3802134 1.00 mm	C3802013 0.75 mm	C3901173 0.75 mm
COK2160F/4 Std.	Use 4		C4893693 Std.
COK2132F/4 0.50 mm			C4892795 0.25 mm
COK2134F/4 1.00 mm	2) C3904166	Use 1	C4892796 0.50 mm
To order an In-Frame Kit change OK to IK			C4892797 0.75 mm
* Piston Kit consists of:			
1) 1 C3907163 Piston Std., 1 C3802230 Ring Set Std., 1 C3901793 Piston Pin, 2 C3901706 Ret.			
2) 1 C3908815 Piston 0.50 mm, 1 C3802232 Ring Set 0.50 mm, 1 C3901793 Piston Pin, 2 C3901706 Ret.			
3) 1 C3908816 Piston 1.00 mm, 1 C3802234 Ring Set 1.00 mm, 1 C3901793 Piston Pin, 2 C3901706 Ret.			
1) Front Seal	1) Top Gasket Set	1) Bushing, Piston	1) Camshaft
2) Rear Seal	2) Bottom Gasket Set	2) Bushing, Cam	2) Tappet
3) Crankshaft	3) Head Gasket	3) Bolt, Con Rod	3) Push Rod
4) Front Seal Sleeve	4) Oil Pan Gasket	4) Con Rod	4) Rocker Arms
5) Rear Seal Sleeve	5) Valve Cover Gsk	5) Bolt, Ex Manifold	5) Camshaft Gear
6) Rectangular Seal	6) Gear Housing Gsk		
7) Crankshaft, Gear	7) Rear Cover Gsk		
1) C3904353	1) C3804896	1) C4891178 x4	1) C3925582 (9)
2) C3353978	2) C3802375	2) C3901306 x1 (3)	2) C3925031
3) C3907803	3) C3921393	3) C3900919 x8	3) C3904679
4) C3906080	4) C3931602	4) C3901569 (7)	4) C3910811 x4
5) C3906081	5) C3902666	C4943979 (8)	C3910810 x4
6) C3912473	6) C3916131	5) C3944593	5) C3907431
7) C3901258	7) C3928493		
	Guide, Valve	1) Intake, Valve Kit	1) Exhaust, Valve Kit
		2) Insert, Valve	2) Insert, Valve
	C3904408	1) C3802355 Kit	1) C3802356 Kit
	C3904409	Consists of:	Consists of:
	Thick W. 60.50 mm IN	C3901117 Valve x1	C3901607 Valve x1
		C3900250 Collet x2	C3900250 Collet x2
	Thick W. 51.75 mm EX	2) C3906854	2) C3904105
	C3906206 (1)	Use 4	Use 4
	Thin Wall		
			1) Spring, Valve
			2) Seal, Valve
			3) Retainer, Valve
			1) C3900276 x8
			2) C3921640 x8 (5)
			C3957912 x8 (6)
			3) C3900299 x8 (5)

ENGINE COMPONENTS



CUSTOM ENGINES



	Description
PC	PRE-COMBUSTION (Pre-Combustion type cylinder head)
DI	DIRECT INJECTION (Direct injection type cylinder head)
SB	SHORT BLOCK (Complete engine assembly, no cylinder head no oil pump)
MB	MEDIUM BLOCK (complete engine assembly, w/cylinder head no oil pump)
LB	LONG BLOCK (Complete engine assembly, w/cylinder head & oil pump)

CRANKSHAFTS



Engine Model	Part No.	Front Seal	Rear Seal
3064	1352419	517656	517660
3066	1253005	2457339	2223910
3126	2715658	2457339	2223910
3204	1W9771	9L7735	7W3202
3208	9N6221	7C6660	7W3200
3304	4N7692	9Y9895	4W0452
3306	4N7693	9Y9895	7C4297
3306	6N8079	7C4297	9Y9895
3406	6I1453	1425867	1425868
3406	7C4859	1425867	1425868
3408	1W5009	1425867	1425868
3408	1W6209	1425867	1425868
3412	2W4088	1425867	1425868
3508	1527625	N/A	N/A
3054, 3054B	1397018	2880422	4W5360
3406B, 3406C	4N0741	3197401	3190785
416B 6FK	2218057	2880422	4W5360
416D	2327400	N/A	N/A
C11	3133996	1694166	7C1728
C12	1694189	1694166	7C1728
C12, 3176C	1694187	1694166	7C1728
C13	3133997	1694166	7C1728
C15	1601799	N/A	N/A
C18	1894918	3197401	1425868
C32	2243252	N/A	N/A
C6.6	2767387	N/A	N/A
C9	2611544	2457339	1608136
D330	8M4505	9Y9895	4W0452
D6R	3442603	9Y9895	4W0452
D8K	6N2823	9N2539	2W2191
G3304, 3304B	3370872	N/A	N/A
G3306, 3306B	3348389	N/A	N/A
G3412	1W6213	1425867	1425868

ENGINE BEARINGS



Part No. Main Bearing	Size (inches)	Engine Model	Part No. Con. Rod Bearing
517588	Standard	3066	517637
517784	0.010	3066	517794
517785	0.020	3066	517795
517786	0.030	3066	517796
1011530	Standard	3114, 3116, 3126	2246638
1450163	0.010	3114, 3116, 3126	7C6976
1450165	0.020	3114, 3116, 3126	7C6977
7C6973	0.030	3114, 3116, 3126	N/A
1077708	Standard	3114, 3116	2246638
1450162	0.010	3114, 3116, 3126	7C6976
1450164	0.020	3114, 3116, 3126	7C6977
7C6963	0.030	3114, 3116, 3126	N/A
1077708	Standard	3126	2246638
4W8092	Standard	3145, 3150, 3160, 3208	9N5923
8N9022	0.010	3145, 3150, 3160, 3208	9N5924
8N9023	0.020	3145, 3150, 3160, 3208	9N5925
8N9023-030*	0.030	3145, 3150, 3160, 3208	N/A
8N9023-040*	0.040	3145, 3150, 3160, 3208	N/A
8N9020	0.050	3145, 3150, 3160, 3208	9N5926
4W8093	Standard	3204	8N6308
8N8976	0.010	3204	1N3821
8N8972	0.020	3204	1N3822
8N8972-030*	0.030	3204	1N3822-030*
8N8972-040*	0.040	3204	8N6308-040*
8N8974	0.050	3204	1W3906
4W8092	Standard	3204	8N6308
8N9022	0.010	3204	1N3821
8N9023	0.020	3204	1N3822
8N9023-030*	0.030	3204	1N3822-030*
8N9023-040*	0.040	3204	8N6308-040*
8N9020	0.050	3204	1W3906
8N8973	Standard	3204	8N6308
8N8971	0.020	3204	1N3822
8N8975	0.050	3204	1W3906
1W0312	Standard	3204	8N6308
1W1661	0.010	3204	1N3821
1W1662	0.020	3204	1N3822
1W1663	0.050	3204	1W3906
4W8093	Standard	3208 Late	7E7894
8N8976	0.010	3208 Late	9N5920
8N8972	0.020	3208 Late	9N5921

ENGINE BLOCKS

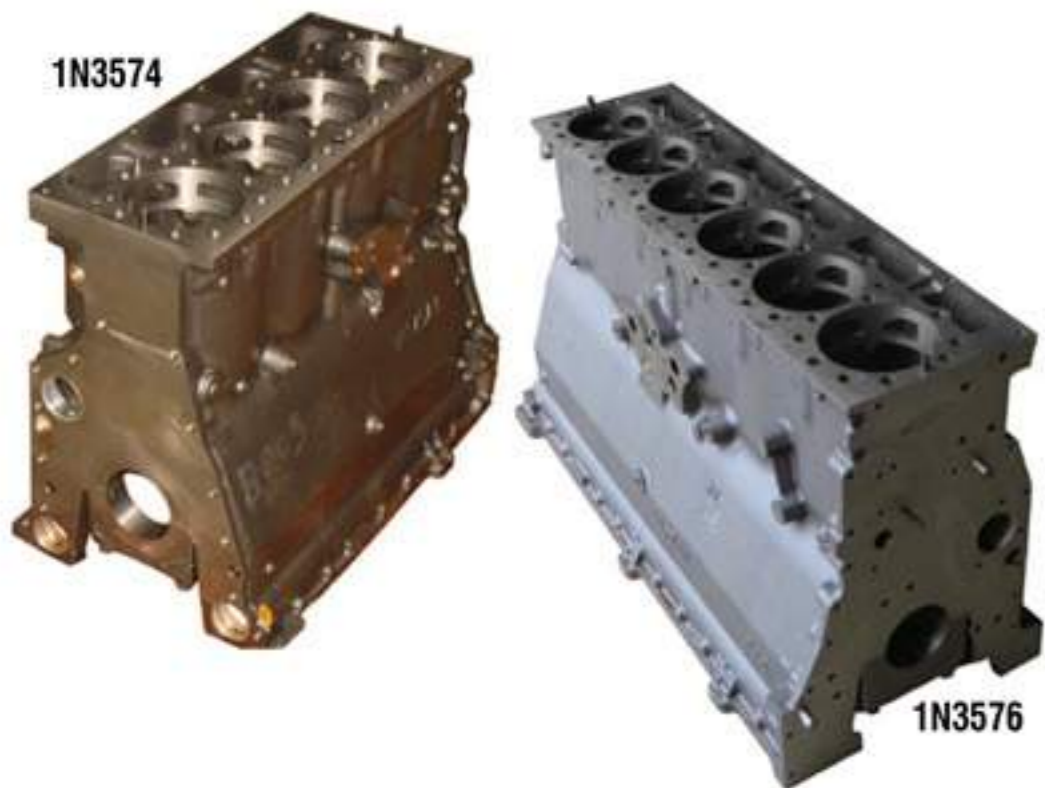

Part No.	Engine	Serial No.
1N3574	3304	02B, 04B, 05B, 09Z, 1NS, 1PS, 10E, 13E, 2WL, 37Y, 78P, 83Z, 9HK, H4G, A4E
7N6552	3304	12Z, 07Z, 4XB, 10E, 09Z, 1NS, 1PS, 1BZ, N4F, 02B, 04B, 05B, 13E, 37Y, 78P, 83Z, 9HK, H4G, A4E
1N3576	3306	02B, 04B, 05B, 09Z, 1NS, 1PS, 10E, 13E, 2WL, 37Y, 78P, 83Z, 9HK, H4G, A4E

INFRAME OVERHAUL KITS



	INFRAME OVERHAUL KITS	PREMIUM OVERHAUL KITS
Connecting rod		✓
Liners	✓	✓
Pistons	✓	✓
Piston Rings	✓	✓
Piston Pins	✓	✓
Retainers	✓	✓
Rod Bearings	✓	✓
Main Bearings	✓	✓
Thrust Plates	✓	✓
Valve Grinding	✓	✓
Central Gasket Kit	✓	✓
Seals Kits	✓	✓
Lower Gasket Kit	✓	✓

BELTS & HOSES



ENGINE HOSES

Material	Resistance	Temperature Range (in Celcius)
EPDM (Ethylene Propylene)	Used with fireproof hydraulic fluids, hot and cold water and alkalis. Unsatisfactory with oils, gasoline, halogenated solvents and acids.	-50 to 150C
Blue Silicone	Heavy duty pressure connections in hostile engine environments. Resists hardening, cracking, cold leaks, steam and many chemicals.	-54 to 177 C
Red Silicone	Typically used between the turbocharger and the engine.	-54 to 260 C

SERPENTINE BELTS



Part No.	RIBS	Lenght (MM)
1359505	7	1790
1003725	8	1054
1417116	8	1093
2363842	8	1230
2414981	8	1345
2414982	8	1395
2679281	8	1430
1908143	8	1450
2260443	8	1480
1906560	8	1515
1644599	8	1523
2202945	8	1585
2432143	8	1610
2129353	8	1790
1983611	8	1816
1851911	8	1824
2884641	8	1840
2193303	8	1860
2466296	8	1900
2486195	8	2010
2601527	8	2005
2201856	8	2041
3341623	8	2050
1855872	8	2095
2631830	8	2110

BELT TIGHTENER



Part No.	CAT Engine	International Navistar	Jonh Deere
1333543	3176		
1333544	C-10, C-12	1814719-C1/C2	RE2490, RE37981, RE68715
1333545	C10, C12		

PULLEYS



Part No.	Engine Model
1421988	C7, C9, C10, C12
1445611	C7, C9, 3126E
1979641	C7, C9, C13, C15
2278313	C11, C13

RUBBER HOSES



Heater Hoses

Part No.	Desc.	Hose I. D.		Hose O. D.		Max Work Pressure	
		(in)	(mm)	(in)	(mm)	(psi)	(kPa)
5P0767	HOSE	0.625	15.9	0.94	23.9	62	437
5P0765	HOSE	0.750	19.0	1.06	26.9	50	350

Radiator Hoses

Part No.	Desc.	Hose I. D.		Hose O. D.		Max Work Pressure	
		(in)	(mm)	(in)	(mm)	(psi)	(kPa)
5P0763	HOSE	1.500	38.1	2.05	52.3	112	784
5P0764	HOSE	3.500	88.9	4.05	96.8	50	350
5P1251	HOSE	1.000	25.4	1.55	39.6	140	980
5P1252	HOSE	1.125	28.6	1.68	42.8	135	945
5P1253	HOSE	1.250	31.8	1.81	46.0	125	875
5P1254	HOSE	1.310	33.3	1.87	47.5	125	875
5P1255	HOSE	1.375	34.9	1.93	49.1	120	840
5P1256	HOSE	1.625	41.3	2.18	55.5	100	700
5P1257	HOSE	1.750	44.5	2.31	58.7	100	700
5P1258	HOSE	1.875	47.6	2.43	61.8	90	630
5P1259	HOSE	2.000	50.8	2.55	65.0	88	616
5P1260	HOSE	2.250	57.2	2.81	71.4	88	616
5P1261	HOSE	2.375	60.3	2.93	74.5	80	560
5P1262	HOSE	2.500	63.5	3.05	77.7	75	525
5P1263	HOSE	2.750	69.9	3.31	84.1	60	420
5P1264	HOSE	2.875	73.0	3.43	87.2	60	420
5P1265	HOSE	3.000	76.2	3.55	90.4	60	420
5P1266	HOSE	3.250	82.6	3.81	96.8	50	350
5P1267	HOSE	3.750	95.3	4.31	109.5	40	280
5P1268	HOSE	4.000	101.6	4.55	115.8	38	266
5P1269	HOSE	4.500	114.3	5.05	128.5	30	210
5P1270	HOSE	5.000	127.0	5.55	141.2	25	175

POWER TRAIN



BEVEL GEARS & GEAR SETS

Bevel gears and gear sets are:

- ✓ **100% roll tested** against master gears to check for proper match, noise and any small imperfections that may have been created in handling or heat-treating.
- ✓ **Quench pressed** during heat treatment to minimize distortion and maximize close tolerances.
- ✓ **Grounded** with a machine that uses **diamond honing to remove most of the distortion and imperfections** created during heat treatment. Ground gears are quieter and provide longer life.
- ✓ **Shot peening and micro finishing** are used to relieve the stress created in the material of the gear during the forging, cutting and heat treating processes.

Gears

Part No.	Qty. of Teeth	Shaft/Pinion	Machine Model
1P6265	49T	9P9000	D6D, 977L, D6E
1122255	51T	N/A	631, 633
2G5768	58T	1095562	12G, 130G, 140G
2V2006	40T	1V9822	966C, 528
2V3687	38T	7V6790	980C
2V5881	40T	2V5608	518, 930
3V8777	40T	6W1629	613C, 950B, 950E
4D3898	32T	2D3609	12E
4V5393	39T	4V5388	814B, 815B, 816B, 966D
5M7740	58T	9P9000	D6, D6C, 977, 977K
6D0687	32T	N/A	12E, 12F, 120, 14E, 140
6K5625	47T	6K3674	920
6W2900	40T	N/A	D20D, D250D
8D1858	63T	8D2106	16G, 16H
8D2116	63T	1095979	14G, 14H
8D3669	46T	8D4335	621B
8D6491	53T	2G8872	120G
8E7860	29T	6Y5946	D8L, D9N, D9R, D10N, 589
8K6015	47T	6K2085	950, 613
8K9661	55T	N/A	D4D, 955L, 951C
8P1183	47T	8P1182	D5/E/B, 561C
8P6241	29T	3T2273	D8L, D9L, 590
8R8335	45T	9C8669	966F
8R9215	44T	1120742	950F, 960F
8V3135	16T	8V3134	960, 966C

Part No.	Qty. of Teeth	Shaft/Pinion	Machine Model
9C8205	40T	9C8204	815B, 816B, 966D, 966E
9C8219	46T	9C8218	815B, 816B, 966D
9C8277	38T	9C8276	980C, 980F
9H1918	49T	N/A	D8, D8H
9K3413	43T	4K6212	528, 814, 966C
9P1925	35T	9W5150	D6H, D7H, 578
9S9541	49T	9S9541	D6C, D6D special appl.
9V9833	49T	6W8267	992C, 992D

Gear Sets

Part No.	Description	Machine Model
1075608	GEAR SET	416C, 420D, 424D, 426C
1120739	GEAR SET 44:14	1T62G, 950G, 950H, 950, 962G
1189117	GEAR SET	416C/D, 420D, 424D, 426C
9R2479	GEAR SET-BEVEL (10/35)	416, 426
9R5241	GEAR SET-BEVEL (9/37)	D8H, 416, 426, 583H
9R9399	GEAR SET-BEVEL (10/31)	416B, 426B, 428B, 436B
9R9444	GEAR SET BEVEL (11/43)	416, 416B, 426B, 428B
9R9445	GEAR SET BEVEL (15/31)	416B, 426B, 428B, 436B, 438B

CARRIERS



Part No.	Application
1043133	D9N
1107209	325B L
1107228	330B L
1107243	330B
1127308	D9R
1128041	966DE, 966F
1128042	980F, D7R, D8N
1293046	980G
1294300	966G/H, 972G
1864117	416B/C, 416
2105924	416E, 416D

Part No.	Application
1M4153	D8K, D9G/H
1P9663	977K/L 983
1T0226	571A, 572E, D7E
1T1481	936E, 950B/E
1V1409	910, 920
1V2281	950, 613B
1V3335	930
2P4408	D4D, 920, 930
2V5722	966DE, 966F
3P0306	120G, 140G
3P1609	14G/H, 16H
3P2415	980C/F, 826C
3P3103	988G, 980F, D9R
3P3775	D9N, D9L
3T3294	D10N, D10R
3T4007	D6R, D7R, D8N
3T5021	D6R, D7R, D8N
3T5200	D8N, D6H, D7H
4E2166	938F/G
4S5940	D5, 955K
4S5980	N/A
4V8541	950B
4V9823	916, IT18B
5M7875	D6C/G, D7G
5S7023	D5, 955L
5V6177	518, 936
6C0739	215
6G7213	120G, 120H
6P0748	D4C, D3C, 926F
6S3011	910
6T0275	926, 926E
6T3726	D9T
6Y1336	D8N, D8R, D8T
6Y1604	980F/C, 826C
6Y4819	966D
6Y4846	D7R, D8T
6Y7879	966
7G4589	980F, 980C
7G5444	936, 936E
7G5445	962H, 962G
7G5684	D7H
7G7218	980F
7I7728	322B, 325L
7K1848	966
7T1124	D8L

FILTERS



FORCEMAC
MOVES YOUR EARTH

AIR FILTERS



Primary Air Filter	Secondary Air Filter	Primary Air Filter	Secondary Air Filter
1006845	1006848	4N0015	N/A
1059741	N/A	4N0326	4N0313
1063969	1063973	4P0710	1131578/4P0711
1070266	1127448/1491912	4S5348	N/A
1080671	1080672	4S8337	4S8340
1106326	1106331	4S8833	4S8834
1131578	1131579	4W5228	1N4864
1232367	N/A	5I5208	N/A
1236855	1236856	5S4282	3S4745/3S9606
1304678	1304679	6I0273	6I0274
1318822	1318821	6I1450	6I1451
1327165	6I2504	6I2499	6I2500
1327168	8P5343	6I2501	6I2502
1348726	1402334	6I2503	6I2504
1355788	1355787	6I2505	6I2506
1421339	1421340	6I2507	6I2508
1421403	1421404	6I2509	6I2510
1467472	1467473	6I2509	6I2510
1517737	1890202	6I6582	N/A
1527217	1527219	6N6071	6N6072
1805474	1805475	7C1572	N/A
2065234	2065235	7N1225	4N0015
2124478	2124477	7W3920	2S1284/7C1062
2229020	2229021	7W5216	1P8482/7N1308
2277448	2277449	7W5313	1P8482/6N6444
2310167	2310168/2098217	7W5316	1P7360/1P8482
2335182	2335184	7W5317	2S1286/9S9972
2453818	2453819	7W5389	2S1285/4N0313
2456375	2456376	7W5495	1P7360
2465009	2465010	7W9853	7W9567
2515886	1W3636	7Y0404	5I5208
2525001	2525002	7Y1196	7Y1197
1282686*	6I2502	7Y1323	7Y1322/5I5208
2567902	2567903	8N5006	N/A
3I2013	N/A	8N5504	4W6691
3N2896	2S1286	8N6309	8N2556
3S9606	3S4745	8T7462	8T7463
4I7575	6I6582	4S8337	4S8340
4L9852	4L9851		
4L9853	N/A		

AIR FILTER INDICATORS



Knowing when to change the air filters of your machine is a critical part of your machines service. Stop changing the air filters of your machine too late or too soon by using Air filter indicators.

Air filters indicators:

- ✓ Help you reduce filter cost by reducing filter changes when working under low dust working conditions.
- ✓ Indicate the remaining lifetime of your filter.
- ✓ Help improve engine performance.

Part No.	Description
0965028	INDICATOR
1W0613	INDICATOR
7S0687	INDICATOR
7W7417	INDICATOR
8N2694	INDICATOR

OIL & FUEL FILTERS



Engine Model	Engine Oil Filter	Fuel Filter Primary	Fuel Filter Secondary	Component
12E	8B5935		1R0750	Motor Grader
120H	1R0658		1174089 1R0753	Motor Grader
140B	8B5935			Motor Grader
320	5I7950		9M2341	Excavators
320L	1R0658 7W2326		5I7951 1383098 1634465	Excavators
416/B, 426/B, 428/B	7W2327		1383098 0676987	Backhoe Loaders
426B	7W2327	1383098	1311812 1383098 676987	Backhoe Loaders
433C, 436B, 438B	7W2326		1383098/1311812 1634465	Backhoe Loaders
931B, 931C, 935B	1R0713		1R0710	Track-Type Tractor
966F	1R0658	9M2341	1R0711 1R0750	Wheel Loader
953	1R0714		1R0710 1R0750	Track-Type Tractor
3054	7W2326			General
3056	7W2327 (2)			Generator Sets
3114			1R0750	General
3116	1R0658		1R0750 1R0751	General

Engine Model	Engine Oil Filter	Fuel Filter Primary	Fuel Filter Secondary	Component
3116	1R0658		1R0750	Truck
3116	1R0658	8N9803	1R0750	Industrial
3126	1R0658		1R0751	General
3176	1R0716 1W8845		1R0749	General
3208	1R0734		1R0750	General
3208	1R0713 1R0734		1R0750	Generator Sets
3306	1R0658	8N9803	1R0750	General
3306	1R0658	9M2341	1R0750	Generator Sets
3406	1R0716	9M2341	1R0750 1R0749	Generator Sets
3508	1R0716 (3) 1R0726 (3)	1R0756 (5)	1R0756 (7) 1R0755 (5)	General
3512	1R0716 (3) 1R0726 (3)	1R0756 (1-5)	1R0756 (5-7) 1R0755 (1-2)	General
3516	1R0716 (3-4) 1R0726 (3)	1R0755 (2) 1R0756 (5)	1R0755 (5-7) 1R0756 (5-7)	General
3145, 3150, 3160	1R0734		1R0710	General
3176B	1R0716 1W8845		1R0749	General
3208T	1R0714	8N9803	1R0750	General
3304, D5H	1R0658		1R0750	General
3304B, 3306C, D330C, D333C	1R0658		1R0750	General
3306B	1R0658	8N9803	1R0750	General
3406, 3408, 3412	1R0716 (1-2)		1R0749	General
3406B	1R0716		1R0749	General
3406B, 3406C	1R0716	9M2341	1R0750 1R0749	Generator Sets
3406C, 3408E, 3408C			1R0749	General
3408E, 3412E	1R0716			General
3412, 3412C	1R0716 (2)	9M2341	1R0749 (2)	Generator Sets
3508B	1R0726 (3)	1R0756 (5)	1R0749 1R0755	General
3612, 3616			1R0756	General
C10, C12	1R0716 1W8845		1R0749	General
D10	1R0716 (2)		1R0711 (2) 1R0749 (2)	Track-Type Tractor
D20D	1R0658			Articulated Trucks
D250D/E, D25C/D, D300D/E, D30C	1R0658		1R0750	Articulated Trucks
D30D	1R0658	1R0750	9M2341	Articulated Trucks
D326, D353D	1R0659			General
D350C, D350D, D35C, D6E	1R0658		1R0750	Articulated Trucks
D35HP, D40D, D44B	1R0716		1R0749	Articulated Trucks
D379B	1R0721			General
D4C, D5C, D10C, D353E	1R0721		4H8792	General
D9G	1R0721		9M2341	Track-Type Tractor
D9H	1R0729		4B5949	Track-Type Tractor
E70B	1R0713 1R0734		5I7951	Track-Type Tractor

HYDRAULIC



Gear Pumps

Part No.	Machine Model
8J2059	225
8J8813	910
3G1686	235B
2387642	267B, 277B, 287B
1262016	322C
1038264	325, 325L
1336912	345B
2P9313	621G
9T1619	631D, 657B, 637D
9T7465	637D, 834B, 988B
9T7414	637G
9T9909	769C, 768C, 771C
9J1295	769C, 771C
6T4257	769D, 771C, 771D
6T3935	771C, 773B/D
3G5868	773B, 775B
2307132	776D, 777D
3T8098	776D, 777D
2305571	777A
1375169	777B, 777D
6E2046	777C
2116626	785C HAA
1363965	854G
2279383	854G
8J4515	931C, 931C LGP
1396084	938G
4T5614	963 LGP
3G9891	966D, 966F
9J5763	980C
3G2858	980C, 980F
8E7538	980F
2356501	980G, 980H
6E4182	988B
3G6856	988F
9T7468	992D
2550625	CS-533E, CP-533E
1T1810	D20D, D250D



Piston Pumps

Part No.	Machine Model
4T7426	225
6E0838	426
3G2848	994
6E1412	120G
8J6730	120G, 130G, 140G
6E5072	12G, 140G, 130G, 160G
6E3136	135H, 140H, 160H
1600196	140G, 130G, 160G, 120G
1243027	140G, 130G, 160G, 12G
1694882	140H, 160H
6E3137	140H, 160H
6E3139	14H, 16H
4T2767	16G
1177760	416, 426
9T6857	416, 428
1555109	416C, 426C, 428C
1809588	416D
2246369	420D, 430D, 432D
1003259	426B
1616634	426C, 428C, 436C
2402647	725, 730
2244432	735, 740
2191964	769D, 771D, 773D



Vane Pumps

Part No.	Machine Model	Part No.	Machine Model
3G7634	518, 518C	6E2928	953
3G7636	518, 518C	6J6320	12F MTR GRADER
3G7635	528, 528B	1052155	446B
9J5136	621	1U2824	613C
9J5059	772, 773A	9J5075	621B
6E2931	916	3G4602	824C
9J5053	920	6E6476	918F
9J5070	950	6E2927	926E
9J8184	950	1287228	928F

Part No.	Machine Model	Part No.	Machine Model
1003414	928F, 938G	3G7641	983B
4T0508	930T	9T1080	D10N
3G4097	936 /F/E, G936	5U0557	D25C
6E6659	950B/E/F, 960F	7J0587	D4D, D4P
1212501	950F	9J5082	D4E
9J5080	951C	7J2194	D5
1214019	960F	9J8198	D5
6E2929	963 LGP	9J8190	D6C
9J8183	966B	9J5058	D7G, D8K, D7F, D9H
9J5049	966C	9J5050	D8K, 77V, D7G, D9H
1214313	966E, 966F	3G5810	D9H
6E6666	966E, 966F	9J8277	D9N
3G7637	977L	3G3895	G936
9J5064	980B	1070035	PATROL 13K
9J5065	980B	1214512	R1600/G/H/ 970F
1392383	980G		
1439722	980G		

HYDRAULIC PUMPS



The Hydraulic system transfers pressure through liquid to drive hydraulic machineries in the lifting of an object. Forcemac hydraulic parts help increase the force to get the desired power needed to operate your machine. Diesel engines drive hydraulic pumps to transmit fluid through control valves to various actuators which become pressurized according to the resistance present.

BEARINGS



Part No.	Application
1545404	416C, 416D, 420D, 424D
1832358	416C/D, 424D, 426C, 420D, 428C, 430D, 436C
2G3686	120G
3G2579	140G, 140M, 160H
3G2581	140G
6Y3548	D7H
7D8889	120M, 12G, 12M, 130G
8D4137	14G
8D4138	14G, 14H, 14M
8D4496	14G, 14H, 14M
8D6629	130G
8D7086	12H, 12M, 140M, 160H
8D7282	12G, 130G, 140G
8D7284	120G, 12G, 130G, 140G
8D7685	320D
8D7996	120G, 120H
8D8168	120H
8D9296	120, 120G
9D0047	120G
9D0057	120G
9D1511	120G
9D1512	120G

COMPOSITE BEARINGS



Typical Applications:

- ✓ Steering linkages
- ✓ Hydraulic cylinder pivots
- ✓ King pin bearings
- ✓ Boom lifts, scissor lifts
- ✓ Cranes, hoists, lift gates
- ✓ Backhoes, trenchers
- ✓ Skid steers loaders, front-end loaders

NEEDLE BEARINGS



Part No.	Engine Model
1F4503	992, D397, D38
1F4622	G348, G349
1J3710	D4H, D6G, D5E
1P3958	992K, 740, 980C, 980K
1P6070	D4H
1S9110	633, 834
1T0655	621

SLEEVE BEARINGS



Part No.	Application
1297768	320, 320B, 320C, 320S, 322B LN, 322C
1372817	325, 325C, 325L, 325LN, 330C
1372818	330C, 330 C L, 330 C LN
1372819	320, 320B, 320C, 320S, 325C, 330B, 345B
1372820	320B, 320C, 320S, 322B, 322L, 325, 325B, 325L, 5080
1372821	330BL
1372822	330, 330L, CAT-3
1372919	315C, 320B, 320BL, 320BLN, 320BN, 320BS, 320C, 320CL, 320D, 320S, 330C, 330CL
1413420	345B, 345BII, 345BL, 365B, 365B
1433841	318 C, 319D, 320C, 321C, 322BL, 322BLN, 322C, TK1051
1483091	345B, 345BL, 345B-II, 345B-L, W345B-II
1633749	315C, 315CL, 320D, 322CL, 325, 325C, 345B, 385B
1928318	322C, 325C, 325CL, 330CL, 330CLN
2285614	315C, 315DL, 320D, 320DL, 323DL, 323DLN, 323DS, 324DFM, 325D, 325DL, 328DLCR, 329D, 329DL, 330D, 330DMH
2285615	315DL, 320D, 320DL, 323DL, 323DS, 324C, 324DFM, 325D, 325DL, 328DLCR, 329D, 329DL, 330D, 385C
2285617	324D, 324DL, 325BL, 325C, 325D, 325DL, 330D, 330DL, 330DLN, M325B, M325D
2285619	330D, 330DL, 330DLN, 336DL, 336DLN, 345D, 345C, 345CL
2285621	320C, 330, 330D, 330D-L, 330D-LN, 330D-MH, 345D, 345C, 345DL, 365C, 365B, 365BII, 365C, 365C-L
2285621	330D, 330D L
2285622	322C, 345C, 345D, 345C, 345C-L, 345DL, 365C, 385B, 385C, 385C-L
2291092	311C, 311DLRR, 312C, 313C, 314C, 314DCR, 314DLCR, 320C, 320DL, 324DL, 325D, 329DL
2291096	315DL, 319D, 320D, 320C, 320C-L, 321C, 325C, 325CL, 365B
2343749	385B
2402912	320C, 320D, 320DL, 322C, 323D, 323DL, 325C, 325D, 325DL, 330DL, M325D-LM
2402913	312D, 320B, 320BL, 320BLN, 320BS, 320C, 320D

Part No.	Application
2402914	318C, 319C, 320B, 320BL, 320BS, 320C, 322D, 325C, 325BL, 325C, 345B, 345B-II, 345BL, 962GII
2402915	320B, 320C, 320B-L, 320B-N, 320C, 325C, 325C-L, 345BII
2402916	320C, 322CL, 325C, 325CL, 325D, 325DL, 330C, 345C, 345CL, 365CL
2402937	322B, 322C, 322BL
2417231	324D, 329D, 330D, 336D-C9
2417280	324D, 325D, 330D, 336D
2417382	319D L, 319D LN, 323D L, 323D LN, 323D S, 324D L, 325D, 325D L, 330D, 330D L, 330D LN, 336D L, 345 C L
2444360	315DL, 320D, 320DL, 320DLRR, 323D, 323DL, 323DS, 324D, 3244DFMM, 324DL, 325D, 325DL, 330DL, 345CL, M325OLM
2487835	311DLRR, 312D, 312DL, 314DCR, 314DLCR, 3244, 325D, 329D
2627043	416E, 420E, 422E, 428E, 430E, 432E, 434E, 442E, 444E
2627044	416C, 416E, 426C, 436C, 637E

SPHERICAL BEARINGS



Part No.	Part No.	Part No.
058639	3W8357	6Y4457
0665815	3W8570	7J3216
1078126	4D0298	7J3297
1173006	4D2619	7T9147
1174013	4D4431	8G0890
1342733	4T1684	8G4189
1401185	4V2057	8G4259
1587749	5J1446	8G4371
1599311	5J9451	8J4585
1600305	5P7802	8J6861
1649309	6J1144	8J7978
1976439	6J5383	8J8906
1976440	6S3976	8T0333
2159572	6V0444	9J3206
1U2729	6V3249	9J6070
1U3988	6V3340	9J7964
2D8652	6V5002	9M1328
3G3521	6V5003	9M3914
3G5337	6V8105	

RUBBER TRACK



Forcemac, we ensure our rubber tracks are manufactured from only the finest materials and specifically designed to provide excellent performance under a wide range of working conditions. The rubber tracks manufacturing process follows strict ISO 9001 Quality Standards.

Size classification and part number:
Width (mm) x Pitch (mm) (=Distance between metal cores) x Number of Links (=Number of Metal Core)

Mini-Excavators

Tread patterns designed for maximum traction, flotation and durability.



Part No.	Tread Pattern	Comments
180X72X39	P	180mm Wide Conventional Guide
230X48X66	S	230mm Wide Short Pitch Interchangeable Guide
230X48X70	S	230mm Wide Short Pitch Interchangeable Guide
300X52.5NX80	V1	300mm Wide Short Pitch Interchangeable Guide/ Narrow Guide Link
300X52.5WX84	V1	300mm Wide Short Pitch Interchangeable Guide/ Wide Guide Link
300X52.5NX86	V1	300mm Wide Short Pitch Interchangeable Guide/ Narrow Guide Link

Compact Track Loaders

Tread patterns designed for maximum traction, flotation and durability.

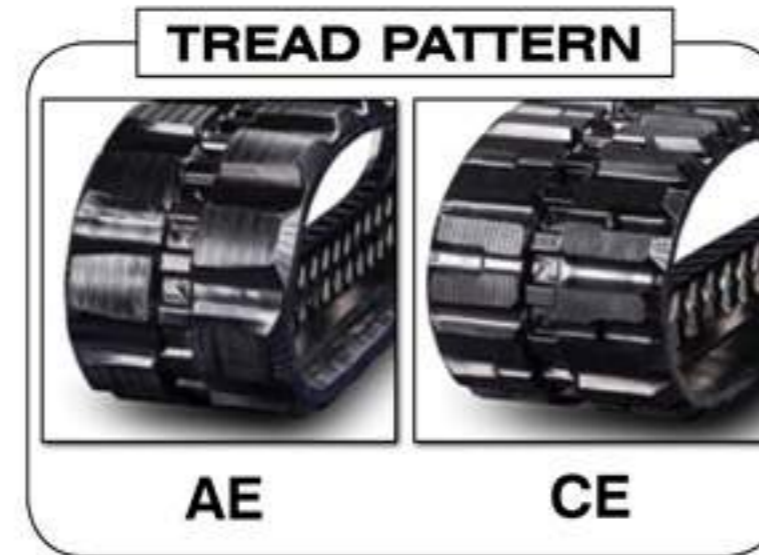

Part No.	Tread Pattern	Comments
B320X86X49	AE	320mm Wide Block Staggered Tread Pattern
B320X86X52	AE	320mm Wide Block Staggered Tread Pattern
T320X86KX52	AE	320mm Wide Block Staggered Tread Pattern
B320X86X53	AE	320mm Wide Block Staggered Tread Pattern
B450X86CX52	CE	450mm Wide "C" Pattern Tread Pattern
B450X86CX55	CE	450mm Wide "C" Pattern Tread Pattern
B450X86CX56	CE	450mm Wide "C" Pattern Tread Pattern
B450X86SDX60	AE	450mm Wide "C" Pattern Tread Pattern
T450X100KX48	AE	450mm Wide Block Staggered Tread Pattern
T450X100KX50	AE	450mm Wide Block Staggered Tread Pattern

Track Loaders

Tread patterns designed for maximum traction, flotation and durability.

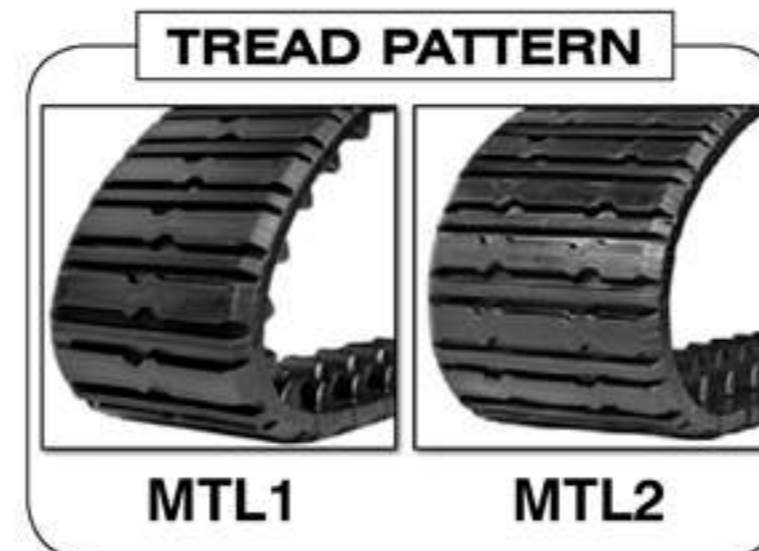

Part No.	Size	Lugs (Per Row)	Tread Pattern
2208161	18(in) x 4(in)	51 (C-Lug)	MTL2
2387664	18(in) x 4(in)	56	MTL2
3258624	15(in) x 4(in)	42	MTL1
3258625	18(in) x 4(in)	51 (Triple Row)	MTL2

Part No.	Machine Model										
	AIRMAN	BOBCAT	CASE	CATERPILLAR	DAEWOO	DITCH WITCH	GEHL	HANIX (NISSAN)	HITACHI	HYUNDAI	IHI
180X72X39		MT50 / 52				JT 520, SK 500					
230X48X66	AX 16 / CBL-3	320/D/G/J		301.5	Solar 015		GE 142	H 15A	EX 16	ROBEX 15-5	
	AX 16-2	322/D/G/J		301.6	Solar 15			H 15B PLUS-2	EX 17/-2/2B	ROBEX 15-7	
230X48X70	AX 16-2 N	323		301.8				H 15B-2	FH 16.2	ROBEX 16-7	
	AX 17	E 16		ME 15				N 120-2	FH 17.2		
	AX 17 CGL-2 N								FH 17.2/PLUS		
	AX 17-2 / N								HE 15		
	HM 10, HM 15			MH 15				N 150-2	HM 15		
300X52.5NX80			CX 14/ZTS	301.5 CR	Solar 015 Plus	MX 15			EX 17U	16-9	15NX
			CX 15 STC	301.6 C	Solar 018	MX 182			ZX 17U-2		18J
			CX 16 B	301.8 C	Solar 018VT						18N
			CX 16 SVR								IS 18J
300X52.5NX86		328G	CK 32	MX 35							
		331/D/E/G	CX 27 B			MX 202	363	H 29A, H 30/A		ROBEX 242-9	
		334/D/G				MX 272	GE 342	H 35/A, H36A		ROBEX 272-9	
300X52.5WX84		E 26						Minicrane		ROBEX 30	
		E 32						N 300-2, N 350-2			
300X52.5NX86	AX 35/36 U							S&B 30 0 /-2			
	AX 36 UCGL							S&B X-1	EX 35U	ROBEX 35-9	
300X52.5WX84			CK 36	303 CR							
				MM 35			353		EX 33		30JX / NX
				MM 35 A			373				32J
				MM 35 B			GE 353				35J/N
				MM 35 T			GE 373				IS 30JX / NX
B320X86X49		T190		MM 40 SR			MB 358				32J
		T550		MX 35							IS 35G/GX
B320X86X52		T570		239							IS 35J
		T590									
B320x86x53		864/FG/G									
		T200									
B450x86Cx52		T630									
		T650									
B450x86Cx55		T250, T300	445 CT								
		T320, T730	450 CT								
B450X86CX56		T750, T760									
				236, 246							CL 45
B450X86SDX60				248/B							
				246 C, 256 C							
				262 C, 268 B							
				279 C							
				289 C/C L							
				299 C							

STEERING & BRAKES

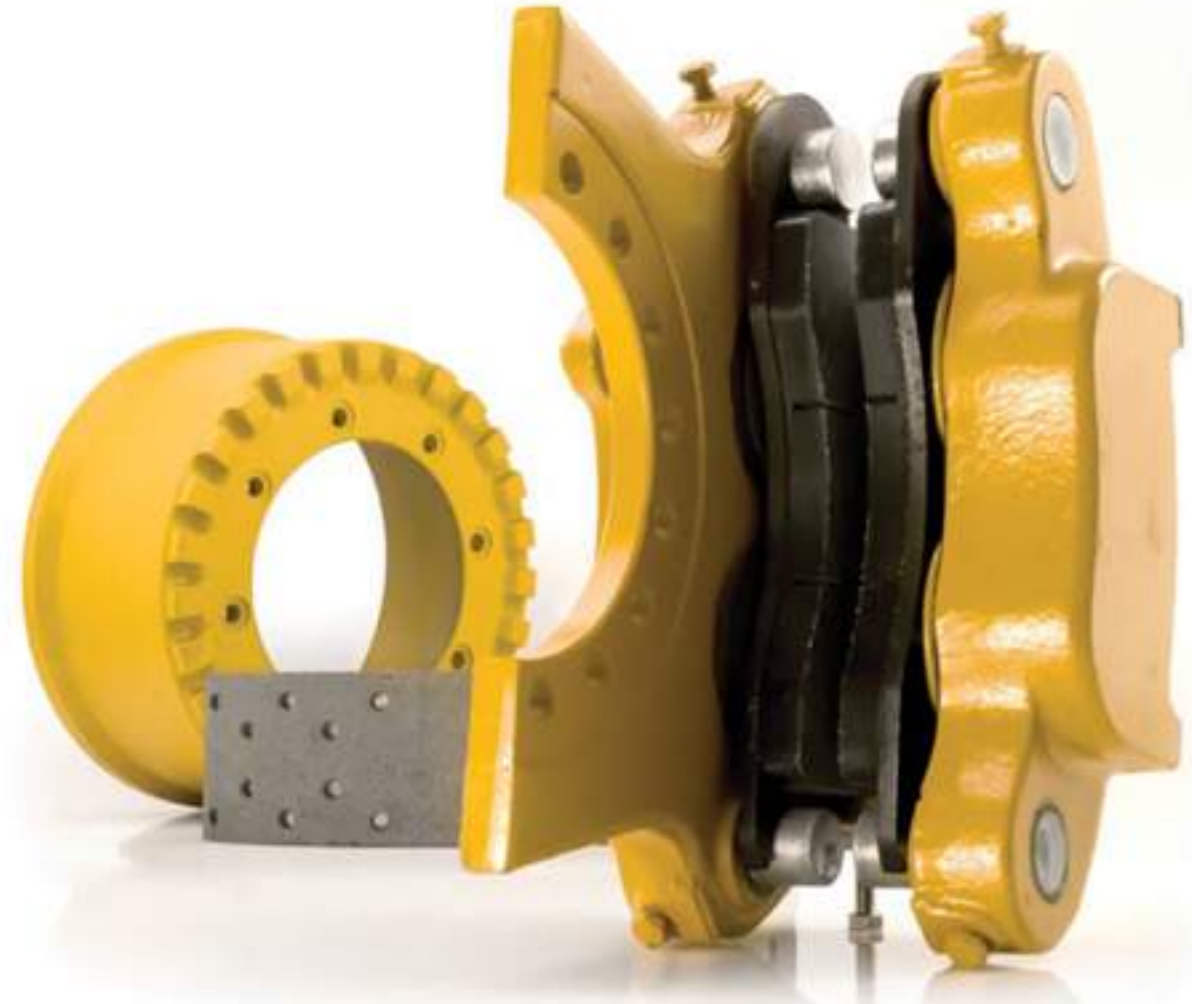

Part No	Description	Machine Model
1029004	ACTUATOR	16G, 16H
1298090	ACTUATOR A	926H, 950H/K, 962H/K, IT62H
1548041	ACTUATOR A	814F, 815F, 816F, 950F, 960F, 966F
1548042	ACTUATOR A	824G, 825G, 826G
3V7028	ACTUATOR GP	980B
5T0925	ACTUATOR GP	130G, 140G, 14H, 120G, 14G, 12G
6W4280	ACTUATOR	980W, 980F
8R2488	ACTUATOR-GP	966R, 966C
8W8357	ACTUATOR G	627E, 627G, 623G, 623E
8W8358	ACTUATOR G	627E, 623F, 627G, 621E, 621G
9V8693	ACTUATOR G	528G, 936, 936E
9V8736	ACTUATOR G	950F, 966F, 814B

Actuator Kits

Part No.	Description	Machine Model
4E5986	ACTUATOR KIT	816B
1870424	ACTUATOR KIT	966F

Parts for Braking System

Part No.	Description
1233426	CYLINDER A
3D2219	CYLINDER A-BRAKE
3D9334	REBUILD KIT MASTER CYLINDER
4K5968	CYLINDER A-BRAKE GR
5T6520	CYLINDER A
5T6533	CYLINDER KIT WHEEL
5T6605	CYLINDER KIT
5T6617	CYLINDER A
5T6618	CYLINDER ASSY
9C0166	CYLINDER G-AIR
9K1591	CYLINDER (MASTER)

ACTUATORS



BRAKE PEDALS



Brake Pedal Assemblies

Part No.	Description
2R0617	VALVE A-W/PEDAL
4E5669	VALVE A-W/PEDAL
4V4154	VALVE A-W/PEDAL
6K1265	VALVE A-W/PEDAL

Pedals and Valves

Part No.	Description
1196744	VALVE GP
2R0696	TREADLE A
4D2287	VALVE A.
7D8075	VALVE A
9V2434	TREADLE A



BRAKE LINING



Brake Lining Discs

Part No.	Application
8W9176	112F, 12E
8R0807	518, 528, 530B
6Y2356	561D
6Y2383	583K
6Y2384	594
9C0567	725, 730, 771C
9C0566	730, 613C, 936E
1149297	771C
1149299	771C
1512628	906, 908
9C8021	926, 930T
2V9135	930
1322084	933

Part No.	Application
1322085	933
8Y4387	955L
8Y4388	955L
6Y2370	977, 983, D6
6Y7164	D3, 931
8Y4138	D4
8Y4139	D4
6Y2357	D5B
6Y1935	D6
8E5820	D6
6Y1937	D6, D7
6Y2364	D7G
6Y1948	D8

COOLING SYSTEM



Reversible Fans

Part No.	Machine Model
1251362	D6R, D6T, D7H & D7HLGP, D8N
1359960	D9R
1479670	N/A
1479672	D8K, 583K, 983B/D

OIL COOLERS



Part No.	Description	Application
1011741	CORE AS	D9R
1047366	CORE A COOLER	235C/D
1134941	CORE AS	416C, 436C
1154517	CORE AS	345B, C10
1245142	CORE AS	5130, 777C, 3508B
1275537	CORE AS	815N, 950
1330125	CORE AS	988G
1414109	CORE AS	777D
1551216	CORE AS	966G, 972G
1838101	CORE AS-OIL	320C, 320C L
1S0172	CORE AS	N/A
1W0156	CORE AS	3408B
1W0219	CORE A OIL	966C
1W0220	CORE AS	955K
1W0223	CORE AS	980B
1W0225	CORE AS	977K, 977L
1W0289	CORE A-OIL	D7H, 12G
2237962	CORE AS	631E, 740B
2674743	CORE AS	3126
2W7590	CORE AS	910
2W7933	CORE AS	815B, 966D, 3306
2W9978	CORE A OIL	D5, D5B, D6C, D6D, D7G
4N5915	CORE A OIL	980B
4P7731	CORE AS	D8, 3406B
4W0419	CORE AS	854K, 992C, 3412C
4W4980	CORE AS	785C, 3512B
4W5056	CORE AS	776D, 785B, 785D
4W5405	CORE AS	3516
4W5412	CORE AS	D10T, C27
4W5549	CORE AS	D398A, G398
4W5550	CORE AS	D379, G379
4W5551	CORE AS	D399
4W7382	CORE AS	3406
4W9822	CORE AS	D8T, C11, C15
6N9211	CORE AS	D7E, 663, 657
6N9213	CORE AS	D343, 988
6N9215	CORE AS	D5, D6C/D, D7F, 966C

Part No.	Description	Application
6N9220	CORE AS	988
6N9514	OIL COOLER	D9H
6N9653	CORE AS	D7E, D8H, D8K
6N9654	CORE AS	D9, D9G, D9H
6N9670	CORE AS	630, 631, 633, 657
6N9752	CORE AS	836B, 173B, 183
7C0145	CORE AS	D9L, 3412B
7C3039	CORE AS	D8L
7C6461	CORE AS	3412, D10N
7C8858	CORE AS	D400E
7N0098	CORE AS	955K
7N0104	CORE AS	D330, 3304
7N0110	CORE AS	D7F, D8K
7N0113	CORE AS	D8H, D6K
7N0125	CORE AS	D353, D353G, G353
7N0128	CORE AS	D4, D4E, D5, D5B
7N0165	OIL COOLER	D6D, 3304
7N3521	CORE AS	3306, D6
7N6668	CORE AS	977K, 977L
7N6677	CORE AS	D6C
7W0205	OIL COOLER	D8K, D8L
7W1762	CORE AS	3208
7W2164	CORE AS	D8L
7W6459	CORE AS	621E, 623F, 637E
7Y1960	CORE AS	320, 320L
7Y1961	CORE A	320
8N4363	CORE AS	D6D

RADIATORS



Application	Part No.
621	5S0602
950	7S2244
120G, 140G	8N0073
120H, 140H, 160H	1857980
12E/F	8N7859
14G	2625755
318C, 320C	1932767
320B	1415722
322B, 325B L	1415975
3304, 3306	4L2114
3306, 3408B, 3406C	4N8190

THERMOSTATS/WATER TEMPERATURE REGULATORS



Application	Part No.
3056	4W8063
3066	518010
3116	1193075
3204	3062103
3208	1028392
3054, 3054C	2202748
3054C, C6.6	2542267
3056E	2169737
3114, 3116	1265869
3116, 3208	9N5121
3116, 3208	9N6341
3304, 3306	1118010
3306, G3612, C12, C15	2477133
3512C, 3516C	2193240
3516, 3512	2485513
3606, 3608, 3612	614955
44H, D4D	9S3808
966C	2S4044
C2.2, 3024	2495541
C9, 3126, 3208	2845421
D342	4W4011
D353	6N4540
G3306	1167577
G3616	614953

ELECTRICAL SYSTEM



ALTERNATORS



Part No.	Voltage	Engine Model	Machine
2490313	24V 150A	C7, C9, C13, C27, C32	12M, 140M, 160M, D6R
6N9294	24V 35A	C7, 3406C, 627F, 3508B	140k, 627F, 12H, Industrial
1125041	24V 50A	3406/C, 3408/E, 3412	16G/H, 627F, 637E, 120H
1005047	24V 50A	3406/C, 3408/E, 3306	16H, 627F, 631E, 769C, 12H
1693345	24V 60A	3406C, C15, C7, C13, 3412E	16H, 771D, 627F, C280-16
2721889	24V 150A	C13, C6.6, C32, C9.3, C7.1	16M, 930K, D11T, 797F
1449954	12V 55A	3034, 3044c	216, 226, 228, 236
3943496	12V 85A	C1.5	216B, 226B, 232B
2035492	12V 110A	3044C, C3.4, 3046, 3034	277C, 259B3, 246C, 939C
2128622	24V 50A	3064, 3066	311C U, 320C/L
517615	N/A	3066	320, 320 L
2128561	24V 54A	C6.4, 3066	323D, 320D
3E7577	24V 75A	3512C, 3408E, 3456, 3306	385B, D8R, 627F, 12H, 797B
3832556	12V 100A	C6.6, C4.4, 3054C	416E, 414E, 422E, Industrial
3832557	12V 120A	420D, 432D, 434F, 416F	416F, 420D, 432D, 434F
1052813	12V 90A	3054/B/C	426C, 428C, 436C, 424D, 416D
1171379	12V 130A	C7, C9, C12, C16, 3126B	460, 85C, 470 R, 480 R, 75C
3062174	24V 150A	C13, C7, C15, 3512B, C27	587T, 583T, D6R, D8T, D7R
1855294	24V 65A	3406E, C7, C13, C9, C15	740, D8R, 336D2, 340D2
2008281	24V 75A	3406E, 3408/E, C15, 3456	740, D9N, 623G, 621G
2002232	24V 75A	C15, 3406E, C18, 3408E	740B, 657G, 631E, 623G, 633E
3445081	24V 115A	C15, C18	772G
2267683	24V 95A	C32, C18, C27, C7.1, C15	777F, D11T, 772G, 390F
1978820	24V 95A	3516, C7, C15, 3516B	789C, 793C, D8T, 140K
3167251	24V 105A	3516, 3406C, C7, C18	793C, 789C, 16H, 793B
2579466	24V 95A	C15, C18	826H, 836H
7N6118	12V 40A	3204	931, D3/LPG, 910
7N4784	12V 40A	3204	935C, 931C, D3C, 931B
8N2268	12V 75A	3204	935C, D3C, 931C, 910, D4C
2357132	24V 65A	C6.6	938H
1052811	12V 55A	3046	939/C, D4C/LGP, D5C, 933
2357133	24V 80A	C13, C9.3, C11, C7.1, C15	972H, 366F, 14M, 329E, 352F
3397766	12V 85A	C4.4	CB54, CB64
3469826	24V 55A	C2.2, 3056E, 3024C	CS-563E, Industrial
6T1195	12V 61A	4.236	CS323, CP-323
3469827	24V 75A	C4.4	CS54B, CP54B, 420E, CS44
2Y8310	28V 21A	3304, 3306/B, 3408B	D4E, D5E, 966C, 930T

AIR CONDITIONING COMPRESSORS



Part No.	Engine Model	Part No.	Engine Model
1540490	3046	1984564	3508
3E1908	3054	1149484	3116, 3126
1717495	3066	1630872	3176C
2457781	3066	2777245	C11
1065122	3116	1835106	C15
7N4296	3208	3050325	C7
2180324	3412	1789570	C9
7N4297	3412	3050324	C9
8T8816	3412		

Part No.	Voltage	Engine Model	Machine
1077977	24V 70A	3116, 3306, 3196, 3176	D6M/LGP, DR7, 365B, 572R
3662756	24V 115A	D6R, D7R, 980H, 950H	D6R, D7R, 980H, 950H
2047449	24V 100A	3408C, 3456, C9, 3176C	D9R, 836G, D6R, D8R, D7R
0969299	24V 30A	N/A	E200B
6T1395	24V 35A	C15, 3406C, 3408C, G3306B	Gas, Industrial, Petroleum
3E7892	12V 85A	3408C, C27, 3412E, C32	HT400, CX31-C9I
2253143	12V 85A	C2.2, C4.4, 3024C	Industrial
3397767	12V 65A	C6.6, C4.4, C3.3, 3054C	Industrial
3491369	12V 85A	3024C, C.2	Industrial
4N3986	24V 60A	3406, 3512, 3508, 3126	Industrial, Gas, Petroleum
1259597	12V 145A	C7, C13, C9, 3196, 3176	Industrial, Petroleum, 95E
5N5692	24V 45A	3512C, 3406E, C15, C18	Industrial, Truck, Petroleum
9W3043	24V 52A	3054, 3116, 3126, 3208	M318, 938G, IT28G, 322C/LN
3991485	24V 75A	M322D/420E/914G	M322, 420E, 914G
1092362	24V 55A	3056/E, 3054/T	M322C, M315, 312, 317/N
2667226	24V 75A	3516B, C18, C7, C32, C9	Marine, Industrial
6T1396	12V 51A	C15, 3406E, G3304, 3306	Marine, Industrial, Gas
2667227	24V 60A	C15, 3508, 3406C/E, C7	Marine, Industrial, Truck
2667224	12V 110A	C7, C15, C9, 3406C, 3126B	Marine, Petroleum, Industrial
1492061	12V 65A	4.236	N/A
7G7889	12V 60A	C7, C9, C13, C18, 3406C	Petroleum, Industrial
5I5178	24V 50A	EL200B	S6KT
3331184	12V 65A	C3.3, C4.4C, 3054, 3056	TH-35-C13I, TH35-C15I
2076036	12V 105A	3054, C32, C13	TH350B, TH220B
1008223	12V 55A	3054, 3056	TH62, TH103, TH63, Industrial
1214134	12V 115A	3176B, 3406C, C15, 3456	Truck, Industrial, Petroleum

GLOW PLUGS



Part No.	Voltage	Engine
1073659	11	3044C, 3046
3H2033	24	977, 955, D315
3T8705	12	3304, 3306, 3406, 3408B
3T8706	24	3412B, 3408B/C, 3306
3T9561	12	D336
3T9562	24	D10, 776, 777, 583
3T9563	32	D398B

RECEIVER / DRYER



Part No.	Application	Part No.	Application
1065532	3406E	1757162	C6.6
1065533	3304	1761902	3066
1065534	C9.3	2573227	C6.6

ALARMS & HORNS



Alarms

Part No.	Description	Voltage
1545428	BACK UP ALARM	N/A
2139100	BACK UP ALARM	12 - 36 Volts
3E6328	ALARM GP	24 Volts
3T1815	BACK UP ALARM	12 - 24 Volts
3701485	BACK UP ALARM	12 - 36 Volts
9G9813	ALARM GP	24 Volts
415-06-22100	BACK UP ALARM	N/A

Horns

Part No.	Description	Voltage
1631201	Forward Warning Horn (Low Tone)	24 Volts
1747875	Forward Warning Horn (High Tone)	24 Volts
5D6998	Air Horn	N/A
7Y3919	Horn As	24-Volt, Low Tone
7Y3920	Horn As	24-Volt, High Tone
9D4049	Air Horn	N/A



FUEL INJECTION



FUEL LINE ASSEMBLY



Eng. Model	Line 1	Line 2	Line 3	Line 4	Line 5	Line 6
3204	4N0471	4N0472	4N0473	4N0474		
3066	5I7707	5I7708	5I7709	5I7710	5I7711	5I7712
3054	1720051	1668797	1013890	1013891		
3204	1W7121	1W7122	1W7123	1W7124		
3204	7N6151	7N6152	7N6153	7N6154		
3304	4N3281	4N3282	4N3283	4N3284		
3304	4P9961	4P9962	4P9963	4P9964		
3304	8L5661	7N3872	8L5663	8L5664		
3304	7N2871	7N2872	8N9733	7N2874		
3304	1W8641	8N4222	8N4223	8N4224		
3306	2Y5721	2Y5722	2Y5723	2Y5724	2Y5725	2Y5726
3306	7N2871	7N3872	8N9733	7N2874	7N2876	
3306	4N3281	4N3282	4N3283	4N8814	6N1965	6N1966
3306	4N9941	4N9942	4N9943	4N9944	4N9945	4N9946
3306	4P9381	4P9382	4P9383	4P9384	4P9385	4P9386
3306	4P9381	4P9382	1044253	1044254		
3306	7C7991	7C7992	7C7993	7C7994	7C7995	N/A
3306	8L5691	8L5692	8L5693	8L5694	8L5695	8L5696
3306	8N1141	8N1142	8N1143	8N1144	8N1145	8N1146
3306	8N4371	8N4372	8N4373	8N4374	8N4375	8N4376
3306	6I0341	6I0342	6I0343	N/A	6I0345	6I0346
3306C	1003831	1003832	1003833	1003834	1003835	1003836
3406	4N9971	4N9972	4N9973	4N9974	4N9975	4N9976

ACTUATORS FOR GOVERNORS



Part No.	Description	Engine Model
1086281*	ACTUATOR A	3512
1187590*	ACTUATOR A	G3508, G3512, G3516
1380777*	ACTUATOR A	3406C
7W6652*	ACTUATOR A	3406B
7W6653*	ACTUATOR A	3408B, 3408C, 3412C, 3412E

Eng. Model	Line 1	Line 2	Line 3	Line 4	Line 5	Line 6
3406	9Y1081	9Y1082	9Y1083	9Y1084	9Y1085	9Y1086
3406	1917941	1917942	1917943	1917944	1917945	1917946
D315, D330	4M1451	8M2042	4M1453	4M1454		
D330	5S7211	8S4002	5S7213	5S7214		
D330C	5S7211	5S7212	5S7213	5S7214		
D333, 1673	7M4331	7M4332	2M6613	2M6614	2M6615	2M6616
D333C	5S7171	5S7172	5S7173	9S1230	5S7175	5S7176
D333C	1N5401	1N5402	1N5403	1N5404	1N5405	1N5406
D333C, 3306	8L5691	8L5692	8L5693	8L5694	2P8890	8L5696
D339	4H9691	4H9692	4H9693	4H9694		
D342	4H9611	4H9612	4H9613	4H9614	4H9615	4H9616
D342	2P2651	2P2652	2P2653	2P2654	2P2655	2P2656
D342	7N791	7N792	2P2653	2P2654	2P2655	2P2656
D343	1S2081	1S2082	1S2083	1S2084	1S2085	1S2086
D343	8S9301	8S9302	8S9303	8S9304	8S9305	8S9306
D353	8N3451	8N3452	8N3453	8N3454	8N3455	8N3456



Plungers & Barrels



Part No.	Description	Engine Model
1082104	PLUNGER	3406
1086631	PLUNGER & BARREL	3406
1P6400	PLUNGER & BARREL	D342, D343
1W6541	PLUNGER & BARREL ASSY	3306B
3S8336	PLUNGER & BARREL ASSY	D336
4N4997	PLUNGER & BARREL	3408B
4P9830	PLUNGER & BARREL	3306
4S5758	PLUNGER A	3204
5I5129	PLUNGER A	3066
6N7527	BARREL/PLUNGER ASSY	D333C, 3306
7N1183	PLUNGER A	3408, 3412
7N1220	PLUNGER A	3406
7S6681	PLUNGER & BARREL ASSY	D334
7W0182	PLUNGER A	3408, 3408
7W5929	PLUNGER & BARREL	3306
8N3539	PLUNGER & BARREL A.	3204
8S3656	PLUNGER & BARREL ASSY	D343, D346
9H5796	PLUNGER & BARREL ASSY	D320A
9H5797	PLUNGER	D330A, D333
9M9788	PLUNGER	3408, 3412

Service Groups



Part No.	Description	Engine Model
3S6638	SERVICE GROUP	D333C/3306
5H7936	SERVICE GROUP	D353
6H3364	SERVICE GROUP	D311/D320
7M7431	SERVICE GROUP	D379/D398
8M1584	SERVICE GROUP	D333C/3306
8N8796	SERVICE GROUP	3304

SEALS AND GASKETS



GASKET KITS FOR C-CLASS ENGINES









Special Gasket Kits for Engine C-7

Part No.	Application/ Description
2690064	GASKET KIT - TURBOCHARGER
2712910	GASKET KIT - WATER PUMP
2853794	GASKET KIT - AIR COMPRESSOR
2919159	GASKET KIT - WATER PUMP INSTALLATION
2933069	GASKET KIT - WATER PUMP INSTALLATION
2974826	GASKET KIT - AIR COMPRESSOR
2974827	GASKET KIT - FUEL SYSTEM
2974828	GASKET KIT - FRONT STRUCTURE
2974830	GASKET KIT - SINGLE CYLINDER HEAD
2974831	GASKET KIT - WATER PUMP INSTALLATION
2974835	GASKET KIT - CENTRAL & LOWER
2974841	GASKET KIT - SINGLE FUEL INJECTOR
2975350	GASKET KIT - SINGLE CYLINDER HEAD
2975867	GASKET KIT - FRONT STRUCTURE
2975894	GASKET KIT - WATER PUMP INSTALLATION
2975909	GASKET KIT - AIR COMPRESSOR
2976161	GASKET KIT - FUEL SYSTEM
2976163	GASKET KIT - AIR COMPRESSOR
2976379	GASKET KIT - AIR COMPRESSOR
2976380	GASKET KIT - FRONT
2976382	GASKET KIT - WATER PUMP INSTALLATION
2978786	GASKET KIT - FRONT STRUCTURE
2978787	GASKET KIT - SINGLE CYLINDER HEAD
2982108	GASKET KIT - FRONT STRUCTURE
2982111	GASKET KIT - SINGLE CYLINDER
2982112	GASKET KIT - WATER PUMP INSTALLATION
2982438	GASKET KIT - AIR COMPRESSOR
2982733	GASKET KIT - FRONT STRUCTURE
2983818	GASKET KIT - FUEL SYSTEM
3083436	GASKET KIT - WATER PUMP INSTALLATION
3085824	GASKET KIT - FUEL SYSTEM
3086327	GASKET KIT - CENTRAL & LOWER
3086345	GASKET KIT - FUEL SYSTEM
3087293	GASKET KIT - FRONT STRUCTURE
3133975	GASKET KIT - FRONT STRUCTURE
3189645	GASKET KIT - CENTRAL & LOWER
3189646	GASKET KIT - FUEL SYSTEM
3189647	GASKET KIT - FRONT STRUCTURE
3189648	GASKET KIT - TURBOCHARGER
3451909	GASKET KIT - OIL COOLER AND LINES

HEAD GASKETS



Part No.	Engine Model	Part No.	Engine Model
2994645	3044	613066	3406
1070979	3046	2835666	3408
1600161	3054	7E7308	3408
1850885	3054	7N9006	3408
7C3803	3054	7E7312	3412
2400205	3056	2188533	3013C
2228331	3066	1992176	302.5C, 303CR
614689	3114	3227487	3024C
1077832	3116	1529864	3034 MARINE
1753234	3116	1465098	3034, 4.236
2051293	3126	1W7879	3054, 4.236
1193790	3176	2584946	3054, C4.4
7N7386	3304	2228330	3064 MHI
7N8022	3304	1334995	3126, C7
1118015	3306	7W2059	3204, 3208
6N7263	3306	2W8128	3406 Early
8N3658	3306	1873306	3406, C10, C12

Material	Gasket Type	Material	Application	Maximum Short Duration Temperatures
NCA-45 	Cork Gasket	Cork/synthetic rubber blend	Medium oil resistance of most sealing application: • Valve Covers • Oil Pans • Transmission Pans	up to 200°C (392°F)
CMP-4000 	Paper Gasket	Compressed MicroPore material, combining a unique synthetic fiber matrix and fully cured Nitrile Butadiene rubber binder	Excellent sealability and torque retention properties for OEM and industrial applications.	up to 350°C (650°F)
HFL-171 	Paper Gasket	Fully cured Nitrile Butadiene rubber binder	Heavy-duty and Industrial applications: • Diesel engine • Transmission • Refrigeration • Piping	up to 290°C (550°F)
HFL-781 	Paper Gasket	Controlled swell gasket material with Styrene Butadiene and natural rubber binders	Heavy-duty oil sealing applications: • Diesel engine • Oil pans • Front covers	up to 290°C (550°F)
M5201 	Paper Gasket	High-density material with fully cured Nitrile Butadiene rubber binder	Heavy-duty diesel engine applications: • Oil resistance • Fuel resistance	up to 290°C (550°F)
MP-15 	Paper Gasket	MicroPore with a Nitrile Butadiene binder	Excellent low flange pressure sealability and bolt torque retention for heavy-duty applications: • Compressors • Diesel engines • Others	up to 205°C (400°F)
N-8092 	Paper Gasket	Reinforced Cellulose with Nitrile binder	Excellent crush resistance at high flange pressure for small engine and compressor applications: • Oil • Fuel • Water	up to 180°C (350°F)

PUMPS

WATER PUMPS & COMPONENTS



Engine Model	Water Pump Part No.	Repair Kit	Impeller	Shaft	Seal Lip	Seal Group	Bearings	Water Seal
3046	1175033	N/A	N/A	N/A	N/A	N/A	N/A	N/A
3046, 3044C	1072473	N/A	N/A	N/A	N/A	N/A	N/A	N/A
3054	610441	1514840	N/A	N/A	N/A	610444	N/A	1514838
3054	3541672	2470144	N/A	N/A	N/A	N/A	N/A	N/A
3054	1514825	N/A	N/A	N/A	N/A	N/A	N/A	1514838
3054	2396142	6V6899	N/A	N/A	N/A	N/A	N/A	N/A
3054, 3056	2396142	2340636	N/A	N/A	N/A	N/A	N/A	N/A
3054C	2307355	2470144	N/A	N/A	N/A	2257738,2257739	N/A	N/A
3056	1487192	N/A	N/A	N/A	N/A	N/A	N/A	1514838
3056E	2346110	2340636	N/A	N/A	N/A	N/A	N/A	N/A
3066	1252991	N/A	517694	517961	N/A	N/A	5L6326	1252990
3066	1838232	N/A	1786634	1838233	N/A	N/A	0968381	1786636
3066, 3064	1252989	N/A	517694	517695	N/A	N/A	5L6326/ 2H3814	1252990
3114, 3116	4P8520	N/A	1523952	2777089	N/A	2W0712	N/A	3505417
3116	4P3683	N/A	1523952	2777089	N/A	1475088	N/A	3505417
3116	7E7398	N/A	1523952	2777089	N/A	N/A	N/A	3505417
3116	1593142	N/A	1523952	2777089	N/A	N/A	N/A	1475088
3116	1265918	N/A	1523952	2777089	N/A	N/A	N/A	2W0172
3116, 3126	3522150	N/A	1523952	2777089	N/A	N/A	N/A	3505417
3116, 3126	1593140	N/A	1523952	2777089	N/A	N/A	N/A	1475088
3116, 3126, 3114	7C6438	N/A	1523952	2777089	N/A	N/A	N/A	3505417
3116, 3126E	4W7589	N/A	1523952	2777089	N/A	N/A	N/A	1475088
3126	3522152	N/A	1523952	2777089	N/A	N/A	N/A	3505417
3126, 3116	3522151	N/A	1523952	2777089	N/A	N/A	N/A	3505417
3126, C7, C9, 3126B/E, 3116	1208402	2641260	1523952	2777089	N/A	N/A	N/A	3505417
3126/B/E, C7	1408068	N/A	1523952	4W0250	N/A	N/A	N/A	1475088
3126/E/B, C7	1593141	N/A	1523952	2777089	N/A	N/A	N/A	1475088
3126B, C7	3522138	N/A	1523952	1291170	N/A	N/A	N/A	3505417
3126B, C7	3522139	N/A	1523952	1291170	N/A	N/A	N/A	3505417
3176, 3176B	1025844	1074912	612847	1030730	8C3100	N/A	N/A	2W0712
3204	2W1223	6V6896	2W3535	1W5646	6V5014, 6V6917	N/A	1W5646	2W0712
3208	2W1225	6V6894	2W3535	9N3078	N/A	N/A	5P7807	2W0712
3304, 3306	1727772	1700560	1725190	2W7255	8C5210	N/A	6H3957	4W3864
3304, 3306	1727778	1700556	1726712	1725188	8H9520	N/A	6H3957	1313815
3304, 3306	1727775	1700556	1726712	1P9929	6V3988	N/A	6H3957	1313815

OIL PUMPS



Part No.	Engine Model
0676925	416
1003717	3056T
1068957	3306
1068958	3306
1161980	C27, C32, 3408E, 3412E
1192925	3114
1614110	3408
1614111	980C, 3406, 3406B
1614112	983B, 3406, 3406B
1614113	988B, 3408
1898777	3116, 3126, C7
2P1784	3304, 3306, D333C
2P7830	12F, 14E, 120B, 3306, D6C
2004497	C7, 3116, 3126
2168625	3056
2335220	3176C, C12, C13
3318905	C9



HYDRAULIC PUMPS



Gear Pumps

Part No.	Machine Model
8J2059	225
8J8813	910
3G1686	235B
2387642	267B, 277B, 287B
1262016	322C
1038264	325, 325L
1336912	345B
2P9313	621G
9T1619	631D, 657B, 637D
9T7465	637D, 834B, 988B
9T7414	637G
9T9909	769C, 768C, 771C
9J1295	769C, 771C
6T4257	769D, 771C, 771D
6T3935	771C, 773B/D
3G5868	773B, 775B
2307132	776D, 777D
3T8098	776D, 777D
2305571	777A
1375169	777B, 777D
6E2046	777C
2116626	785C HAA
1363965	854G
2279383	854G
8J4515	931C, 931C LGP
1396084	938G
4T5614	963 LGP
3G9891	966D, 966F
9J5763	980C
3G2858	980C, 980F
8E7538	980F
2356501	980G, 980H
6E4182	988B
3G6856	988F
9T7468	992D
2550625	CS-533E, CP-533E
1T1810	D20D, D250D

CUTTING EDGE



SUITABLE MODEL

KOMATSU D50

PART NUMBER

CUTTING EDGE : 130-70-61170
END BIT : 140-70-11170
END BIT : 140-70-11180



SUITABLE MODEL

KOMATSU D60

PART NUMBER

CUTTING EDGE: 144-70-11131
END BIT: 140-70-11251
END BIT: 140-70-11261

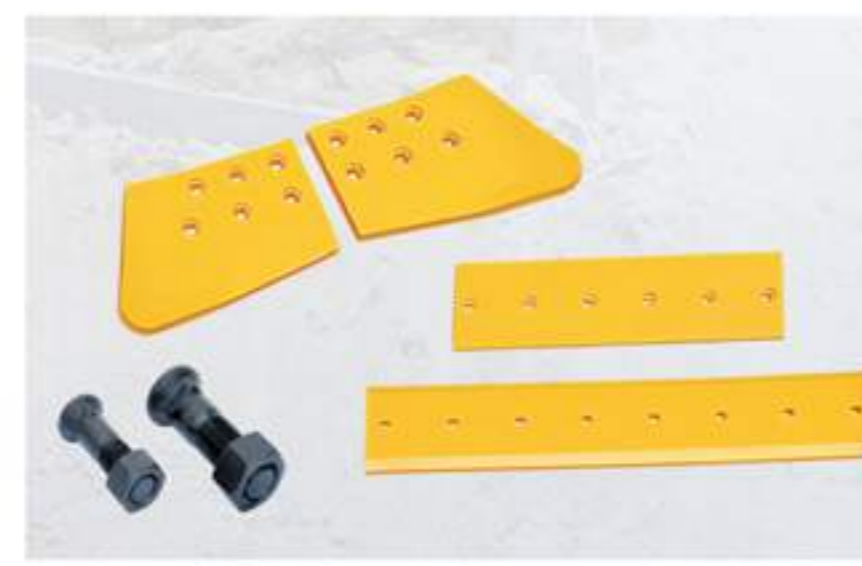

SUITABLE MODEL

KOMATSU D85/TY220

PART NUMBER

CUTTING EDGE: 154-70-11314
CUTTING EDGE: 154-81-11191
END BIT: 150-70-21346
END BIT: 150-70-21356



SUITABLE MODEL

KOMATSU D375 D475

PART NUMBER

CUTTING EDGE: 198-71-11181
CUTTING EDGE: 198-71-31540
CUTTING EDGE: 198-72-11181
CUTTING EDGE: 198-71-31550
END BIT: 195-71-61930
END BIT: 195-71-61940
END BIT: 198-71-31520
END BIT: 198-71-31530



SUITABLE MODEL

CATERPILLAR D7G

PART NUMBER

CUTTING EDGE: 4T2992
CUTTING EDGE: 4T2993
END BIT: 3G8315
END BIT: 3G9316

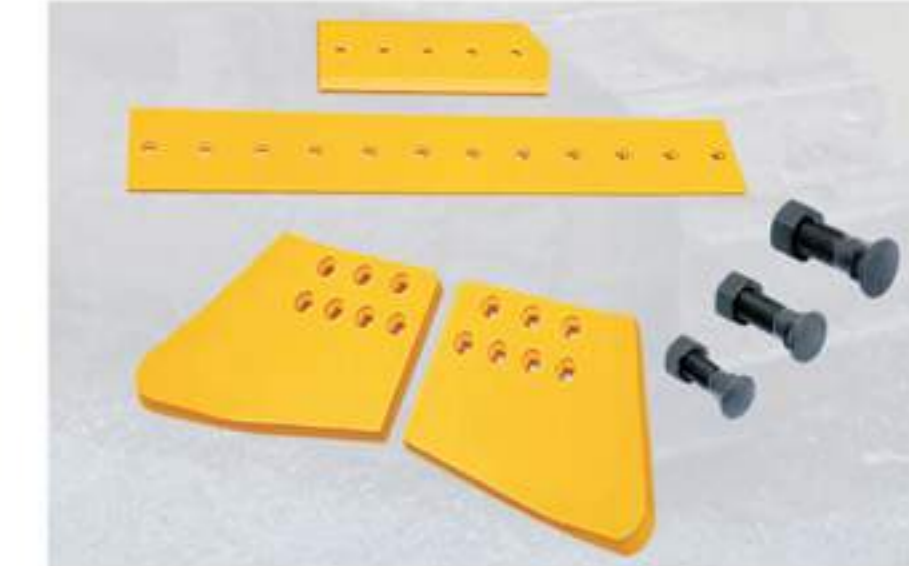

SUITABLE MODEL

CATERPILLAR D9N

PART NUMBER

CUTTING EDGE: 7T5702
CUTTING EDGE: 7T9125
END BIT: 8E4196
END BIT: 8E4197



SUITABLE MODEL

KOMATSU D155/TY320

PART NUMBER

CUTTING EDGE: 175-70-26310
END BIT: 175-71-22272
END BIT: 175-71-22282



SUITABLE MODEL

KOMATSU D275

PART NUMBER

CUTTING EDGE: 17M-71-21550
CUTTING EDGE: 195-71-11654
END BIT: 17M-71-21930
END BIT: 17M-71-21940



SUITABLE MODEL

KOMATSU D355

PART NUMBER

CUTTING EDGE: 195-71-11654
END BIT: 195-71-11173
END BIT: 195-71-11183



SUITABLE MODEL

CATERPILLAR D10N

PART NUMBER

CUTTING EDGE: 9W6608
CUTTING EDGE: 9W6609
END BIT: 8E4198
END BIT: 8E4199

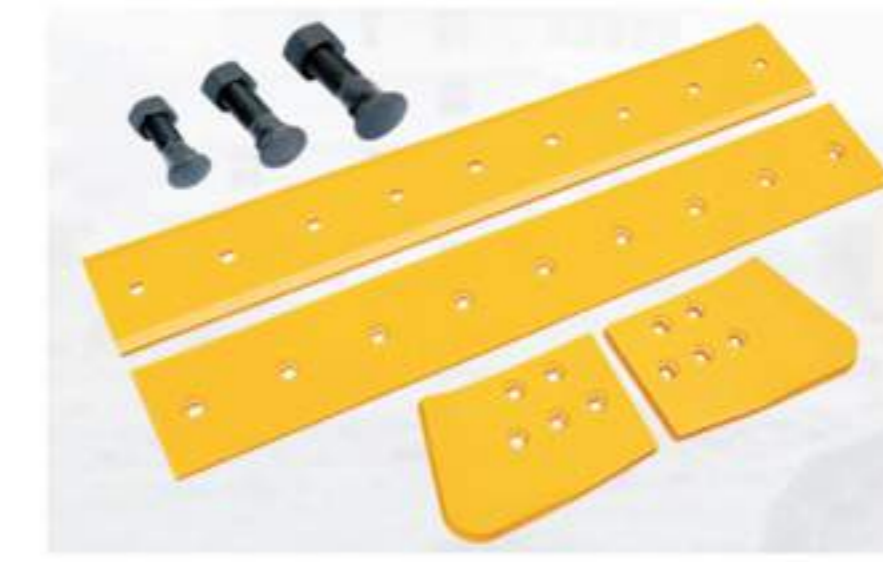

SUITABLE MODEL

SHANTUI TY160

PART NUMBER

CUTTING EDGE: 144-920-1120
END BIT: 144-70-11251
END BIT: 144-70-11261

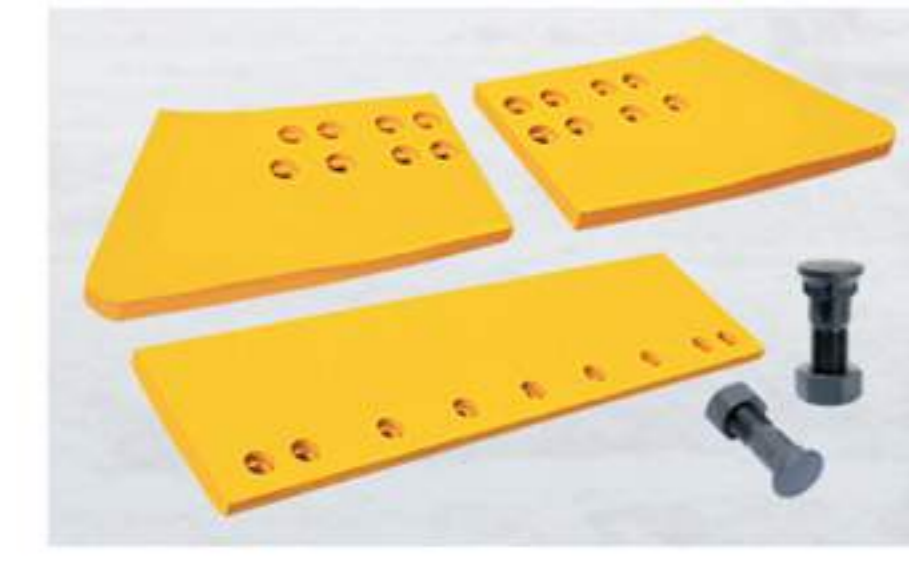

SUITABLE MODEL

CATERPILLAR, KOMATSU 24H

PART NUMBER

CUTTING EDGE: 1093116

CUTTING EDGE



SUITABLE MODEL

GRADER BLADES
11, 13, 15, 17 HOLES

PART NUMBER

5D9553, 5D9554, 5D9556
5D9557, 5D9558, 5D9559
4T2233, 4T2236, 4T2242
4T2244, 7D1158, 7D4509

SUITABLE MODEL

GRADER OVERLAY
12G, 14G, GD511, GD661A-1

PART NUMBER

8E5529, 8E5530, 8E5531
7D2052, 232-70-52190
234-70-32240

SUITABLE MODEL

CATERPILLAR

PART NUMBER

4T2235, 4T2238, 4T2966, 4T3035
4T3037, 4T6511, 4T8317, 4T9603
3G1628, 5D1164, 7D1949, 8J9801



SUITABLE MODEL

KOMATSU **GD705**

PART NUMBER

CUTTING EDGE: 234-70-32240
OVERLAY: 234-70-12710

SUITABLE MODEL

KOMATSU **GD511**

PART NUMBER

CUTTING EDGE: 232-70-12143
OVERLAY: 232-70-52190

SUITABLE MODEL

KOMATSU **GD825**

PART NUMBER

CUTTING EDGE: 235-70-12320
OVERLAY: 234-70-32240

UNDERCARRIAGE

TRACK ROLLER, CARRIER ROLLER



Induction Harden illustration

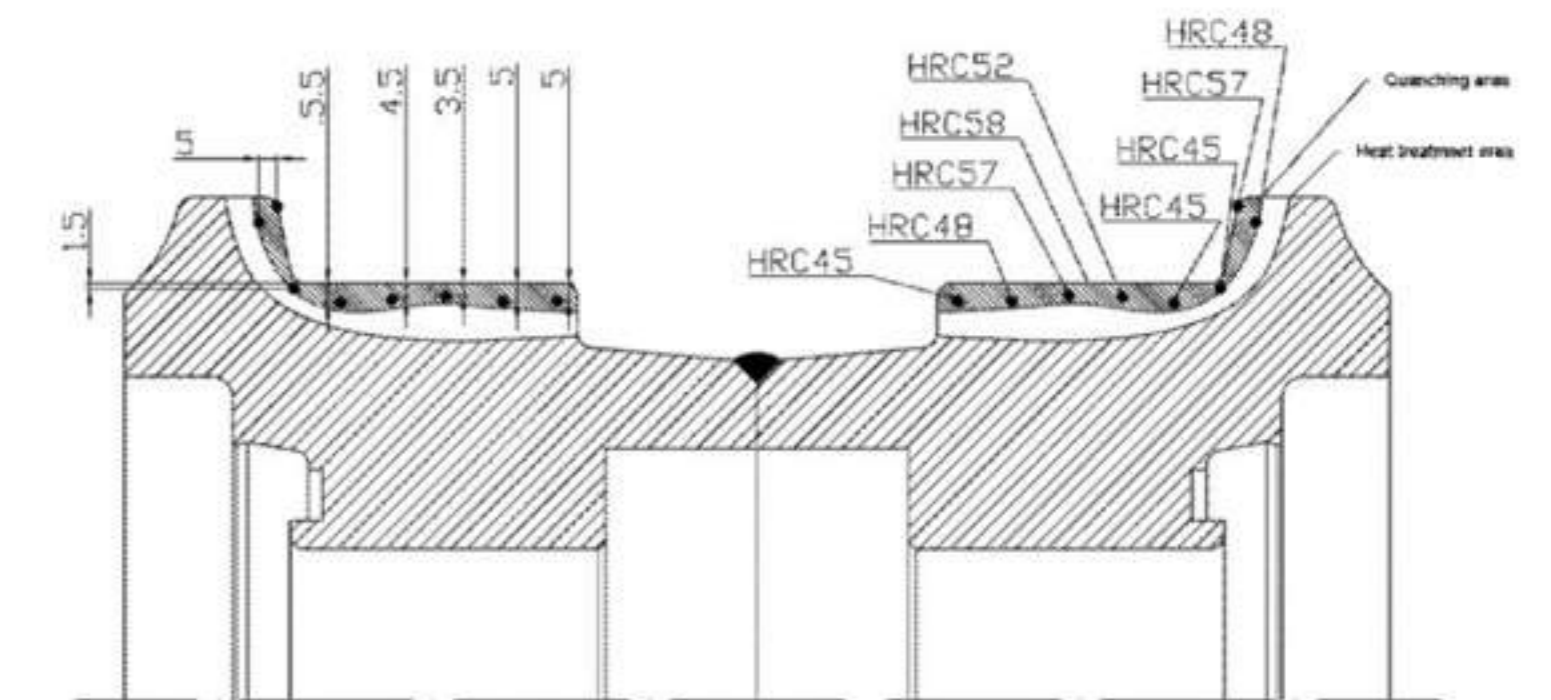

TRACK ROLLER HEAT TREATMENT
Surface Harden: HRC 54-57
Surface Harden Depth: 8 -10 mm
Corner Harden Depth: 1.5mm-2mm

1-4mm Hardness: HRC 51-54
4-6mm Hardness: HRC 46-51
6-8mm Hardness: HRC 42-46
8-10mm Hardness: HRC 40-42

SPROCKET, SEGMENT

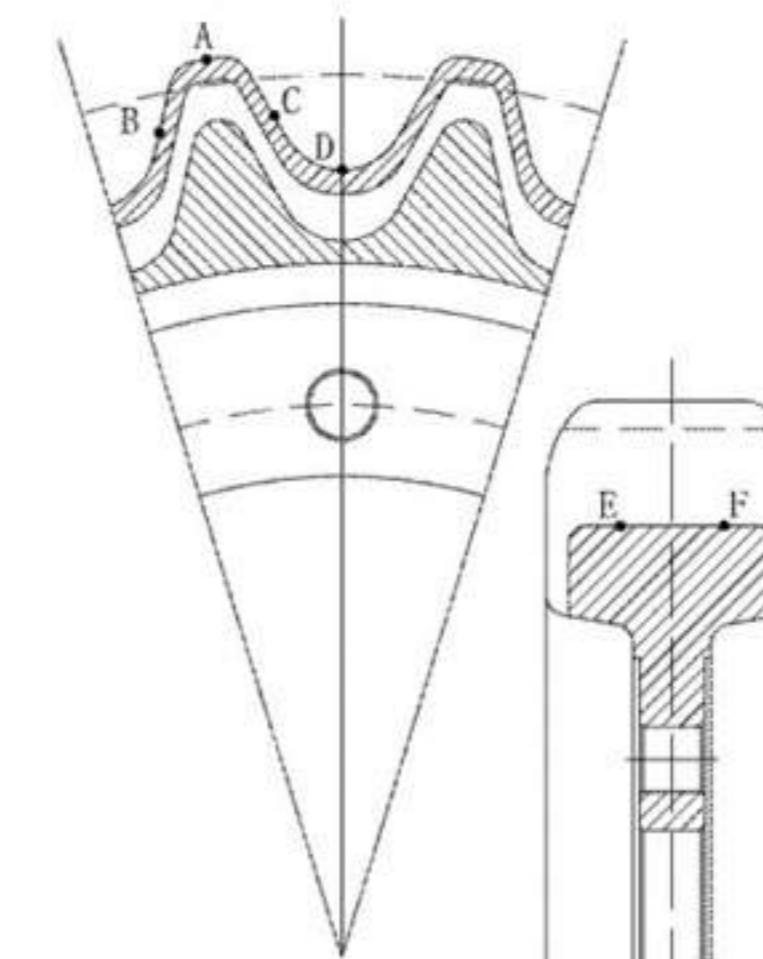

SPROCKET/SEGMENT HEAT TREATMENT

Surface Harden: HRC 52-54
A: 10-12MM, Hardness above HRC 40
B/C: 4-6MM, Hardness above HRC40
D: 4-6MM, Hardness above HRC 40
E/F: 4-6MM, Hardness above HRC 40

UNDERCARRIAGE

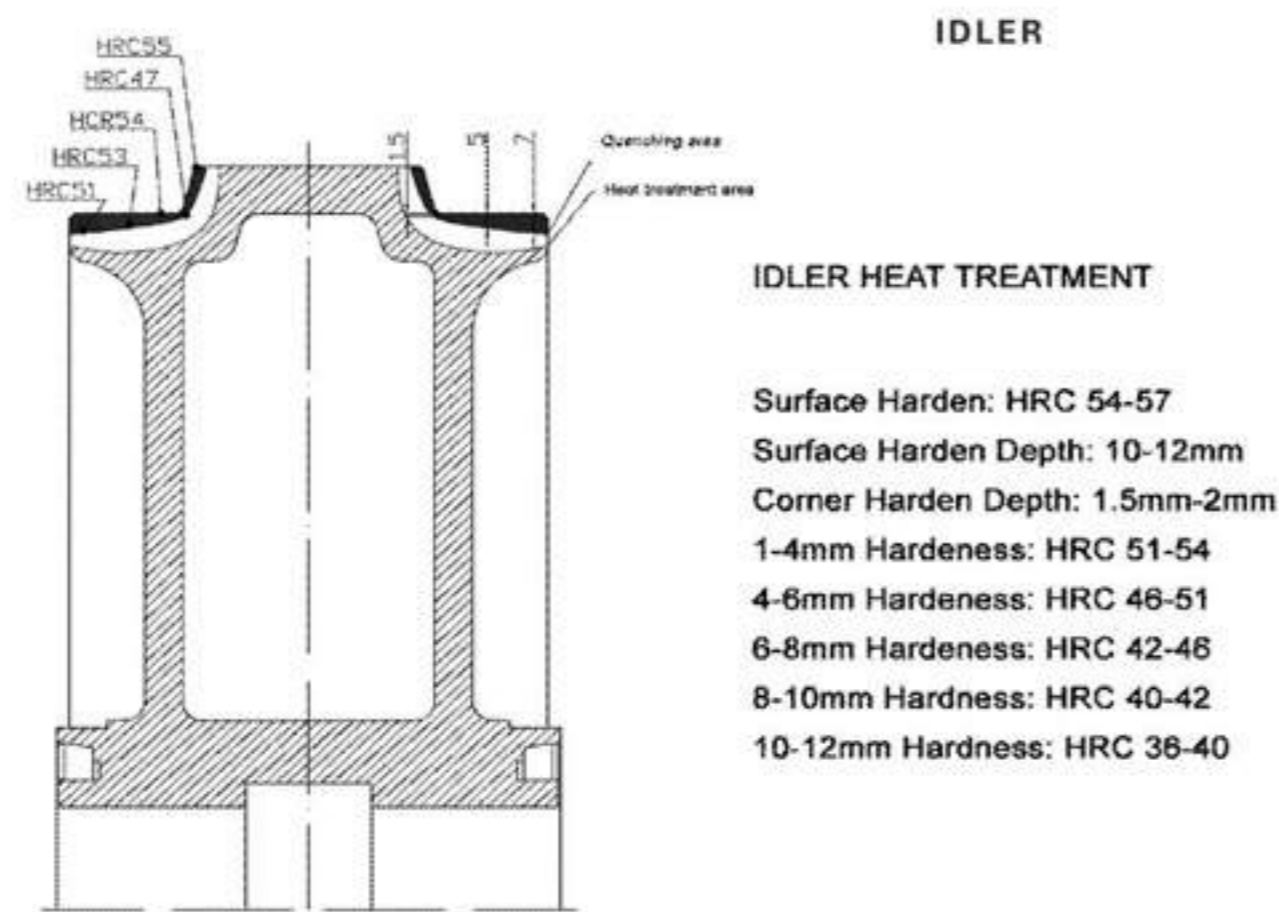
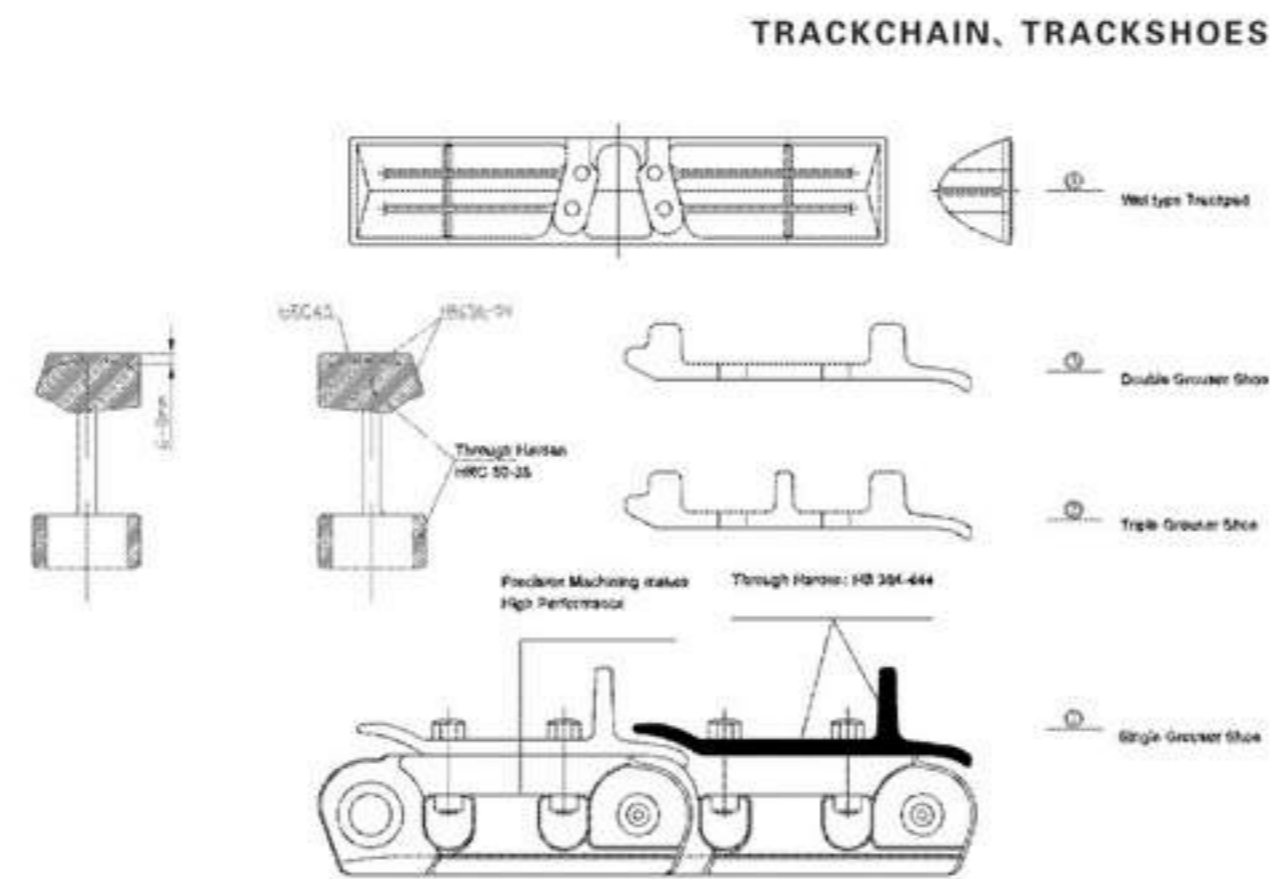

Products applicable for the machine models

BULLDOZERS

KOMATSU BULLDOZER	D20/21	D30/31	D50	D60/65-8	D60/65-12
	D85ESS-2	D85-8/21	D85-12	D155A-1/2	D155A-3/5
	D275A-3/5	D355A-3/5	D375A-3	D475	
CATERPILLAR BULLDOZER	D3C	D4D	D5/D5B	D5H/D6M	D6D/H/R
	D7R/G	D8N/	D8K	D9N/R/T	D10N/R/T
	D11N/R/T				
NEW HOLLAND	FL 4	FL6	FL8		
DRESSER	TD15C	TD20E	TD25E	TD30	TD40

EXCAVATORS

KOMATSU	PC60-5/7	PC100-5/6	PC200-5/7/8	PC300-5/7/8	PC400-5/7/8
	PC650				
CATERPILLAR	CAT312	CAT320/322	CAT325	CAT330	CAT345B
	E70B	E110B	E200B	E215/225	E235
HITACHI	EX60-1/2/5	EX100-3/5	EX150	EX200-1	EX200-2/3/5
	EX300-1/3/5	EX400-1/3/5			
	ZX70	ZX110/120	ZX200	ZX200-3	ZX330
	ZX330-3	ZX350	ZX470	ZX850	
JCB	JS70	JS110/120	JS130/140	JS200/220	JS240
	JS330	JS360			
KOBELCO	SK30/SK40	SK55	SK60	SK100/120	SK200-3/6/8
	SK220	SK235	SK330-6/8	SK907	
SUMITOMO	SH60	SH120	SH200	SH300	SH400
HYUNDAI	R55/60	R130/140	R200	R210	R290/360

VOLVO	EC140	EC210/240	EC290	EC360	EC460
	EC700				
DOOSAN	DH55	DH130	DH220	DH280/300	
KATO	HD400/450	HD550	HD700	HD820	
MITSUBISHI	MS40/45	MS110/120	MS180		
SAMSUNG	SE210	SE280	MX292		
FIAT HITACHI	FH150	FH200	FH220	FH300	
CASE	450	550	CX210	CX270	
FIAT KOBELCO	E135	E215E	E265	E305	E385

Mini Excavator Series

KOMATSU	PC10	PC20-5/7	PC30	PC40-5/7	
CATERPILLAR	CAT301.5	CAT302.5	CAT303.5/304	CAT305/306	CAT307
HITACHI	EX20	EX30	EX40	EX55	EX60-1/2/5
	ZX25	ZX35	ZX70		
JCB	JCB801.5	JCB802	JCB803/804	JCB805/806	JCB808

GROUND ENGAGING TOOLS



Reference Chart

Part No.	Dimensions (mm)							
	A	B	C	D	E	F	G	H
1402864	87	46	15	38	17	20	--	--
2227570	88	45	16	34	17	20	44	4
2227571	88	45	13	32	13	20	44	4
3507198	86	45	10	38	20	24	--	--



Part No.	Holder Part No.	Machine Model
1402864	1519941	RM-250C, PM-465, RR-250, RM-330, PM 201, RM-500, RM-350, PM-565B
2227570	2414559	PM-201
2227571	N/A	T6B, T9B, T15B, PC205B, PC408B, PC412B, PC404
3507198	1519941	PM565, PM465, RM250C

BIT CUTTERS



1402864 2227570 2227571 3507198

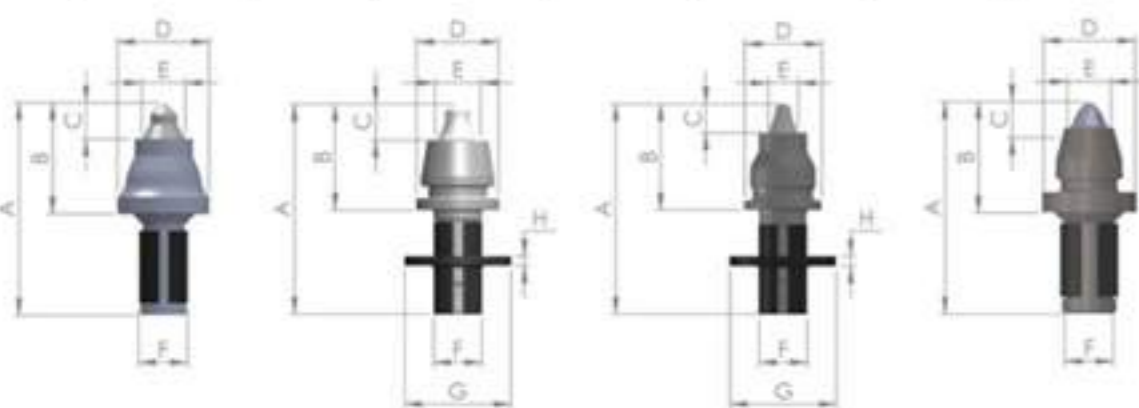

END BITS



Bulldozers & Compactors End Bits General Duty End Bits

Model Engine Application	Blade Model	Thickness		General Duty End Bits		Bolts	Nuts	Washers
		(in)	(mm)	(Left Hand)	(Right Hand)			
D4, D4 LGP, D5, D5 LGP	Straight	0.88	22	3G8322	3G8321	3F5108(6)	4K0367(6)	5P8247(6)
D6	Angle	1.18	30	6Y4410	6Y4411	5J4773(6)	2J3506(6)	5P8248(6)
D6, 815F	Angle	0.88	22	3G8296 3G8298	3G8295 3G8297	3F5108(6) 4F7827(6)	4K0367(6) 2J3506(6)	5P8248(6)
D6, 815S	Straight	0.88	22	3G8320	3G8319	5J4773(6)	2J3506(6)	
D7	Universal	0.88	22	3G8294	3G8293	6F0196(7)	2J3505(7)	5P8249(7)
D7	Universal	1.38	35	9W6198	9W6199	6F0196(7)	2J3505(7)	5P8249(7)
D7, D8, 814/6, 824/6, 835	Angle	1.12	28	3G8316	3G8315	6F0196(7) 5J2409(7)	2J3505(7) 2J3507(7)	5P8249(7)
D8	Semi-U	1.58	40	3G8278 3G8280	3G8277 3G8279	4J9058(7)	2J3507(7)	5P8250(7)
D8	Universal	1.58	40	3G8286 3G8288	3G8285 3G8287	5J2409(7)	2J3505(7)	5P8249(7)
D8	Semi-U	1.12	28	3G8300 3G8302	3G8299 3G8301	4J9258(7)	2J3507(7)	5P8250(7)
D8	Angle	1.18	30	3G8318	3G8317	4J9208(7)	2J3507(7)	5P8250(7)
D8	Angle	1.58	40	8E4194	8E4193	4J9058(7)	2J3507(7)	5P8250(7)
D8	Semi-U/ Angle	1.97	50	9W8652 9W8654	9W8651 9W8653	4J9258(7)	2J3507(7)	5P8250(7)
D8, D9	Semi-U	1.58	40	3G8284	3G8283	4J9208(7) 8J2928(7)	2J3507(7)	5P8250(7)
D8, D9	Semi-U/ Universal	1.38	35	3G8292	3G8291	4J9208(7) 8J2928(7)	2J3507(7)	5P8250(7)
D8, D9	Universal	1.97	50	8E4196	8E4197	4J9058(7) 8J2928(7)	2J3507(7)	5P8250(7)
D9	Semi-U	2.16	55	8E4198	8E4199	6V8360(7)	3K9770(7)	4K0684(7)
D9, 824	Semi-U	1.58	40	1U1546 3G8282	1U1545 3G8281	6V8360(7) 8J2928(7)	3K9770(7) 2J3507(7)	4K0684(7) 5P8250(7)
D10	Universal	1.75	45	8E4198	8E4199	5P8823(7)	3K9770(7)	4K0684(7)
825		1.12	28	3G8288	3G8287	4F4042(7)	2J3507(7)	

Extended Wear Life End Bits

Model Engine Application	Blade Model	Thickness		General Duty End Bits		Bolts	Nuts	Washers
		(in)	(mm)	(Left Hand)	(Right Hand)			
D4, D4 LGP, D5, D5 LGP	Power Angle	0.88	22	4T5408	4T5407	3F5108(3)	4K0367(3)	5P8247(3)
D6	Angle	1.18	30	9W1876	9W1875	5J4773(6)	2J3506(6)	5P8248(6)
D6	Straight/ Angle	1.18	30	4T4454	4T4455	5J4773(6)	2J3506(6)	5P8248(6)
D8	Universal	1.58	40	7T4090	7T4091	5J2409(7)	2J3505(7)	5P8249(7)
D8	Semi-U	1.12	28	7T4089	7T4088	4J9258(7)	2J3507(7)	5P8250(7)
D8	Angle	1.18	30	7T4090	7T4091	4J9208(7)	2J3507(7)	5P8250(7)
D8	Angle	1.58	40	8E4538	8E4537	4J9208(7)	2J3507(7)	5P8250(7)
D8, D9	Semi-U/ Universal	1.38	35	8E4540	8E4539	4J9208(7) 8J2928(7)	2J3507(7)	5P8250(7)
D8, D9	Universal	1.97	50	8E4540	8E4539	4J9058(7) 8J2928(7)	2J3507(7)	5P8250(7)
D9, 824	Semi-U	1.58	40	8E4542	8E4541	6V8360(7) 8J2928(7)	3K9770(7) 2J3507(7)	4K0684(7) 5P8250(7)
D10	Universal	1.75	45	8E4542	8E4541	5P8823(7)	3K9770(7)	4K0684(7)
D10, D11	Semi-U	2.36	60	8E4546	8E4545	5P8361(9)	3K9770(9)	4K0684(9)

Finish Dozing End Bits

Model Engine Application	Blade Model	Thickness		General Duty End Bits		Bolts	Nuts	Washers
		(in)	(mm)	(Left Hand)	(Right Hand)			
D3	Power Angle	0.62	16	4T6229	4T6229	3F5108(3)	4K0367(3)	5P8247(3)
D4		0.75	19	4T3044	4T3043	3F5108(6)	4K0367(6)	5P8247(6)
D4, D4 LGP, D5 LGP	Power Angle	0.88	22	4T6229	4T6229	3F5108(3)	4K0367(3)	5P8247(3)
D4, D4 LGP, D5, D5 LGP	Straight	0.88	22	4T3052	4T3051	3F5108(6)	4K0367(6)	5P8247(6)
D5		0.75	19	3G4285	3G4285	5J4773(4)	2J3506(4)	5P8248(4)
D5	Power Angle			8E7078	8E7079	5J4773(4)	2J3506(4)	5P8248(4)
D5		0.88	22	8E9378	8E9379	5J4773(4)	2J3506(4)	5P8248(4)
D5	Angle	0.75	19	4T3050	4T3049	3F5108(6)	4K0367(4)	
D6	Angle	1.18	30	9W8875	9W8874	5J4773(6)	2J3506(6)	5P8248(6)
D6	Straight/ Angle	1.18	30	4T4436	4T4435	5J4773(6)	2J3506(6)	5P8248(6)
D6, 815F	Angle	0.88	22	4T3042	4T3041	3F5108(6) 4F7827(6)	4K0367(6) 2J3506(6)	5P8248(6)

TOOTH



CAT J200: 416, 426, 428, 436, 910, 931, 935, 307					
Part #	Style	U.W/KG	PIN	LOCK	Type
1U3201	Short	1.20	8E6208	8E6209	1
1U3202	Long	1.30	8E6208	8E6209	2
1U3202 P	Self Sharpening Long	1.30	8E6208	8E6209	13
9W 8209 / 1U3202 TL	Tiger	1.35	8E6208	8E6209	11
135-8208 / 1U3202 W TL	Twin Tiger	1.47	8E6208	8E6209	10
4T2203	Abrasion	1.60	8E6208	8E6209	3
1U3209	Penetration	1.00	8E6208	8E6209	5
CAT J225: 446, 933					
Part #	Style	U.W/KG	PIN	LOCK	Type
6Y6223	Abrasion	2.60	8E6208	8E6209	3
8E4222	Heavy Duty Long	2.50	8E6208	8E6209	12
6Y8229	Penetration	2.20	8E6208	8E6209	5
CAT J250: 916, 930, 936, 941, 943, 951, 953, 205, 214, 225, 229, 311, 312, 320					
Part #	Style	U.W/KG	PIN	LOCK	Type
1U3252	Long	3.00	8E6258	8E6259	2
1U3252 P	Self Sharpening Long	3.00	8E6258	8E6259	13
9W 8259 / 1U3252 TL	Tiger	3.00	8E6258	8E6259	11
135-8258 / 1U3252 W TL	Twin Tiger	3.80	8E6258	8E6259	10
1U3252 RC	Rock Chisel	4.00	8E6258	8E6259	14
1U3252 SYL	SYL	3.30	8E6258	8E6259	8
4T2253	Abrasion	4.00	8E6258	8E6259	3
9N4253	Heavy Duty Abrasion	5.90	8E6258	8E6259	4
4T2253 RP	Abrasion Penetration	5.50	8E6258	8E6259	7
9N4252	Heavy Duty Long	4.00	8E6258	8E6259	12
9J4259	Penetration	2.60	8E6258	8E6259	5
CAT J300: 950, 953B, 966, E180, 215, 219, 235, 205, 214, 315, 320, 322					
Part #	Style	U.W/KG	PIN	LOCK	Type
1U3302	Long	4.40	9J2308	8E6259	2
1U3302 P	Self Sharpening Long	4.50	9J2308	8E6259	13
9W 8309 / 1U3302 TL	Tiger	4.30	9J2308	8E6259	11
135-9308 / 1U3302 W TL	Twin Tiger	5.70	9J2308	8E6259	10
1U3302 RC	Rock Chisel	6.00	9J2308	8E6259	14
1U3302 E	Tip - Extra	5.50	9J2308	8E6259	16
183-5300	MS	5.70	9J2308	8E6259	15
1U3302 SYL	SYL	4.20	9J2308	8E6259	8
4T2303	Abrasion	6.40	9J2308	8E6259	3
9N4303	Heavy Duty Abrasion	6.50	9J2308	8E6259	4
4T2303 RP / PT	Abrasion Penetration	7.00	9J2308	8E6259	7
9N4302	Heavy Duty Long	5.70	9J2308	8E6259	12
135-9300 / 4T2303 RP2	Heavy Duty Penetrator	9.00	9J2308	8E6259	9
9J4309	Penetration	4.10	9J2308	8E6259	5
CAT J350: 966B, 977, 980, E180, E240, 213B, 214B, 215, 229, 320, 322, 325, 330					
Part #	Style	U.W/KG	PIN	LOCK	Type
1U3351	Short	5.60	8E6358	8E6359	1
1U3352	Long	6.50	8E6358	8E6359	2
168-1351	Long	6.30	8E6358	8E6359	2
1U3352 P	Self Sharpening Long	6.40	8E6358	8E6359	13
9W 8359 / 1U3352 TL	Tiger	6.90	8E6358	8E6359	11
135-9358 / 1U3352 W TL	Twin Tiger	7.20	8E6358	8E6359	10
1U3352 RC	Rock Chisel	7.80	8E6358	8E6359	14
1U3352 E	Tip - Extra	7.00	8E6358	8E6359	16
168-1359	MS	8.00	8E6358	8E6359	15
1U3352 SYL	SYL	7.60	8E6358	8E6359	8
4T2353	Abrasion	8.00	8E6358	8E6359	3
9N4353	Heavy Duty Abrasion	11.50	8E6358	8E6359	4
4T2353 RP / PT	Abrasion Penetration	11.00	8E6358	8E6359	7
9N4352	Heavy Duty Long	9.00	8E6358	8E6359	12

TOOTH



CAT Side Pinned Weld-On Two-Strap Adapter					
Part #	Family	Edge Thickness	U.W/KG	Model	Type
135-9354	J350	40	14.50	966	12
125-8404	J400	50	18.80	980	12
1U1350	J350	40	14.65	966	11
1U1351	J350	40	10.50	966	11
1U1352	J350	40	10.50	966	11
113-0354	J350	45	14.50	980	11
113-0355	J350	45	15.00	980	11
113-0356	J350	45	15.00	980	11
125-8404	J400	45	18.70	980	2
125-8405	J400	45	19.40	980	2
125-8406	J400	45	19.40	980	2
114-0464 / 8E3464	J460	50	22.50	988	2
114-0465 / 8E3565	J460	50	23.00	988	2
CAT Side Weld On Double Strapped Adapter					
Part #	Family	Edge Thickness	U.W/KG	Model	Type
119-3205	J200	19	1.75	416, 436, 446	9
119-3204	J200	25	1.75	416, 436, 446	9
6Y3224	J225	20-22	3.00	E70B, 307, 446	9
6Y3254	J250	25	3.9	E200B, 205-213, 311, 312	9
3G6304	J300		6.70		3
3G6305 / 7T3305	J300	30-32	7.70	215	3
3G6306 / 7T3306	J300		7.70		3
8E9490	J300		7.80		3
8E9495	J300	36	7.30	320, B, 315	3
8E9496	J300		7.30		3
3G8354 / 7T3354	J350		9.80		3
3G8355 / 7T3355	J350	38-40	9.30	225, 219, 215, 320	3
3G8356 / 7T3356	J350		9.30		3
7T3404	J400		15.20	235FS, 231SD, Series	3
7T3405	J400	45	14.60	300, 231D,	3
7T3406	J400		14.60	C/D/S	3
CAT Style Weld On Center Double Strapped Adapters					
Part #	Family	Edge Thickness	U.W/KG	Model	Type
9W1304	J300	40	6.10	215, E180, B	10
3G8354 SL	J350	40	10.00		10
6I6354	J350	45	10.00		9
6I6404	J400	45	13.50		9
6I6464 / 159-0464	J460	50	21.60		9
6I6554	J550	60	35.00		9
6I6604	J600	70-75	58.00		9
CAT Style Scarifier Spike & Tips For 12, 14, 112, 130, 140					
Part #	Family	U.W/KG	Bolt	Nut	Type
9F5124	Motor Graders	5.60	5K1459	5K1458	3
5B6251	Motor Graders	5.60	5K1459	5K1458	1
101 UNIVERSAL / 101HX	Motor Graders	5.60			1
6Y5230	Motor Graders	1.30			2
2D5572	Motor Graders	1.30			2
31281C	Motor Graders	1.30			4

TOOTH

Part #	Style	U.W/KG	Application	Type
KOMATSU Tooth For PC60 PC1000				
Part #	Style	U.W/KG	Pin	Type
20X-70-14160(PC60)	Standard	1.65	20X-70-00150	PC60
20X-70-23161	Standard	2.13	203-70-74281	PC100
205-70-19570	Standard	4.00	09244-02496	1
205-70-19570 SYL	SYL	4.00	09244-02496	3
205-70-19570 VIP	Tiger	4.90	09244-02496	4
205-70-19570 TVIP	Twin Tiger	5.80	09244-02496	5
205-70-19570 RC	Rock Chisel	6.00	09244-02496	6
207-70-14151	Standard	7.10	09244-02516	1
207-70-14151 SYL	SYL	7.90	09244-02516	3
207-70-14151 VIP	Tiger	7.30	09244-02516	4
207-70-14151 TVIP	Twin Tiger	8.80	09244-02516	5
207-70-14151 RC	Rock Chisel	8.80	09244-02516	6
208-70-14152	Standard	11.00	09244-03036	1
208-70-14152 SYL	SYL	12.00	09244-03036	3
208-70-14152 VIP	Tiger	13.70	09244-03036	4
208-70-14152 TVIP	Twin Tiger	14.00	09244-03036	5
208-70-14152 RC	Rock Chisel	15.40	09244-03036	6
208-70-14270	Standard	13.60	09244-03036	2
208-70-14270 RC	Rock Chisel	16.70	09244-03036	6
209-70-54210	Standard	28.60	209-70-54240	1
209-70-54210 VIP	Tiger	23.75	209-70-54240	4
209-70-54210 RC	Rock Chisel	36.00	209-70-54240	6
21N-72-14290	Standard	42.40	21N-72-00060	1
175-78-31232	D85,D135,D150,D155	17.00	09244-02508	Ripper
195-78-21333	D275,D375	17.00	09244-02508	Ripper

Part #	Edge Thickness	U.W/KG	Family	Type
KOMATSU Adapter For PC60 PC1000				
20X-70-14151(PC60 A)		2.10	PC60	1
202-70-12140		3.00	PC100	1
20Y-939-1180(4)	40	7.90	PC200	3
20Y-70-14520(3.5)	35	7.70	PC200	3
205-939-7120(3.2)	32	6.50	PC200	2
207-939-3120(4.0)	40	13.30	PC300	5
207-934-5120(5.0)	50	24.50	PC300	5
208-70-14142		11.00	PC300	4
208-70-14143		23.75	PC400	6
208-934-5120		24.50	PC400	5
209-70-74140		55.00	PC650	6

Part #	Style	U.W/KG	Application	Type
KOMATSU Side Cutting				
201-70-74171	3 Bolt Hole	6.00	KOMATSU PC100	
201-70-74172	3 Bolt Hole	6.00	KOMATSU PC100	
205-70-74180	4 Bolt Hole	12.00	KOMATSU PC200	2
205-70-74190	4 Bolt Hole	12.00	KOMATSU PC200	2
207-70-34160	5 Bolt Hole	19.00	KOMATSU PC300	3
207-70-34170	5 Bolt Hole	19.00	KOMATSU PC300	3

Part #	U.W/KG	Model	Bolt	Nut	Model
KOMATSU Monoblock Tooth (Bolt Design)					
417-70-81391		7.20			2
419-70-13114/13113	WA250-1	16.70	09218-12523	01643-32780	1
419-70-13164	WA250-3	21.00	09218-12523	01643-32780	5
419-70-13174	WA320-1, WA320-3	21.00	09218-12523	01643-32780	5
423-70-13114/13113	WA380-1, WA380-3	17.50	09218-12219	01643-32260	3
423-70-13154	WA420-1, WA470-3	24.00	09218-12219	01643-32260	4
423-70-13144	WA420-3, WA470-3	24.00	09218-12219	01643-32260	4
418-70-13170	WA180-1	14.70	02290-11422	01643-32260	5
418-70-13160	WA180-3	14.70	02290-11422	01643-32260	5
205-70-54272	Edge 38mm	17.20	02290-11422	01643-32260	5
207-70-54212	Edge 42mm	17.20	02290-11422	01643-32260	5

Part #	Model	U.W/KG	Pin	Model
KOMATSU Loaders Teeth				
202-70-12130	WA250-1, WA320-1,-3	4.30	09244-02496	1
427-70-13941	WA650	53.00	427-70-13790	2

Part #	Style	U.W/KG	Pin	Lock	Type
ESCO Style Conical And Super Conical Teeth					
18S	Sharp	1.00	18PN	18LK	2
18TL	TF	1.10	18PN	18LK	2
18VIP	Tiger	1.10	18PN	18LK	3
18TVIP	Twin Tiger	1.26	18PN	18LK	1
22S	Sharp	1.60	22PN	22LK	2
50VIP	Tiger	13.00	50PN	50LK	3
50TVIP	Twin Tiger	15.10	50PN	50LK	6
50RDX		11.00	50PN	50LK	8
55S	Sharp	25.40	55PN	55LK	4
55VIP	Tiger	21.00	55PN	55LK	3
55TVIP	Twin Tiger	22.75	55PN	55LK	6
55RDX		15.00	55PN	55LK	8

Part #	Style	U.W/KG	Pin	Lock
ESCO And KELLY Style Ripper Teeth				
22RC-10	Ripper Tooth	4.50	25 RP	25 RB
25RC-12	Ripper Tooth	6.40	25 RP	25 RB
35RC-14	Ripper Tooth	12.30	35 RP	35 RB
39RC-17	Ripper Tooth	21.00		

Part #	Model	U.W/KG	Application	Type
VOLVO Tooth And Adapter				
1070-61450	MX8, SE220	7.00		2
1070-61310	SE220	6.90		1
117100041	EC210,MX225,B101	7.20		1
117100031	EC210,MX225,B101	11.00		2
107100630	MX14,SE350LC2/SE450	11.30		1
107100620	MX14,SE350LC2/SE450	20.50		2
T550		14.00		3
T55-A		24.00		4
843	VOLVO460	17.50		3
843-A	VOLVO460	30.00		4

Part #	Model	U.W/KG	Type
Daewoo Tooth And Adapter			
2713-9051 / S55	S55V	1.00	1
S55 HD	S55V	1.10	2
2713-9050	S55V	2.00	3
2713-9041	DH170,220	5.80	7
2713-9042	DH170,220	10.80	9
2713-9038 / 2713-6043	DH280,320	7.50	7
2713-9038 RC	DH280,320	9.70	8
2713-9037	DH280,320	14.10	9
713-00057	T14W	4.20	5

Part #	Model	U.W/KG	Type
Hyundai Tooth And Adapter			
E 161-3027	R 130, 220 (HX80)	6.00	1
E 161-3017	R 130, 220 (HX80)	7.65	2
E 262-3046	R 280, 300, 320 (HX 100)	7.20	3
E 262-3046 RC	R 280, 300, 320 (HX 100)	9.70	4
E 262-3027	R 280, 300, 320 (HX 100)	13.60	5
61E7-0101	R420, R450LC3A, HX160	13.00	3
61E7-0100	R420, R450LC3A, HX160	15.40	5
61N6-31310		6.90	3
61N6-31320		9.90	5

BUCKET



CAT EXCAVATOR BUCKET

BRAND	MODEL	CAPACITY(m3)	MATERIAL	WEIGHT (KG)	TYPE	TEETH
CAT	305.5D	0.19	Q345B	198	HD	GP TYPE
CAT	307C	0.31	Q345B	244	HD	GP TYPE
CAT	312C	0.52	Q345B	584	HDR	ROCK TYPE
CAT	315D	0.73	Q345B	779	HDR	ROCK TYPE
CAT	320D	1	Q345B+NM400	865	HD	GP TYPE
CAT	320D	1	Q345B+NM400	1115	HDR	ROCK TYPE
CAT	320D	1.1	Q345B+NM400	1010	HD	GP TYPE
CAT	320D	1.1	Q345B+NM400	1164	HDR	ROCK TYPE
CAT	320D	1.19	Q345B+NM400	966	HD	GP TYPE
CAT	320D	1.19	Q345B+NM400	1360	HDR	ROCK TYPE
CAT	325D	1.35	Q345B+NM400	1320	HD	GP TYPE
CAT	325D	1.35	Q345B+NM400	1560	HDR	ROCK TYPE
CAT	325D	1.57	Q345B+NM400	1352	HD	GP TYPE
CAT	330D	1.64	Q345B+NM400	1818	HD	GP TYPE
CAT	330D	1.64	Q345B+NM400	2063	HDR	ROCK TYPE
CAT	330D	1.87	Q345B+NM400	2043	HD	GP TYPE
CAT	330D	1.87	Q345B+NM400	2428	HDR	ROCK TYPE
CAT	345	2.1	Q345B+NM400	2200	HDR	ROCK TYPE
CAT	365	4	Q345B+NM400	4400	HDR	ROCK TYPE

VOLVO EXCAVATOR BUCKET

BRAND	MODEL	CAPACITY(m3)	MATERIAL	WEIGHT (KG)	TYPE	TEETH
VOLVO	EC55B	0.2	Q345B	228	HD	GP TYPE
VOLVO	EC60C	0.25	Q345B	291	HD	GP TYPE
VOLVO	EC210B	0.92	Q345B	890	HD	GP TYPE
VOLVO	EC210B	0.9	Q345B	1005	HDR	ROCK TYPE
VOLVO	EC240B	1.1	Q345B+NM400	1070	HD	GP TYPE
VOLVO	EC240B	1.1	Q345B+NM400	1224	HDR	ROCK TYPE
VOLVO	EC290BLC	1.3	Q345B+NM400	1360	HDR	ROCK TYPE
VOLVO	EC360BLC	1.9	Q345B+NM400	2063	HDR	ROCK TYPE
VOLVO	EC460BLC	2.1	Q345B+NM400	2346	HDR	ROCK TYPE
VOLVO	EC460BLC	2.3	Q345B+NM400	2516	HDR	ROCK TYPE



Rake Bucket

Rake Bucket

Main use for clean up fragment, grass, filiform metal, tree branch, and can be dig shallow channel to plant crop. We can make different width between the teeth according customer. application environment

BUCKET

KOMATSU / HITACHI EXCAVATOR BUCKET

BRAND	MODEL	CAPACITY(m3)	MATERIAL	WEIGHT (KG)	TYPE	TEETH
Komatsu	PC110	0.48	Q345B	450	HD	GP TYPE
Komatsu	PC200	0.8	Q345B	890	HD	GP TYPE
Komatsu	PC210	1	Q345B+NM400	980	HD	GP TYPE
Komatsu	PC240	1.2	Q345B+NM400	1250	HD	GP TYPE
Komatsu	PC300	1.4	Q345B+NM400	1628	HDR	ROCK TYPE
Komatsu	PC360	1.6	Q345B+NM400	1900	HDR	ROCK TYPE
Komatsu	PC400	1.9	Q345B+NM400	2050	HDR	ROCK TYPE
Komatsu	PC450	2.1	Q345B+NM400	2250	HDR	ROCK TYPE

BRAND	MODEL	CAPACITY(m3)	MATERIAL	WEIGHT (KG)	TYPE	TEETH
Hitachi	ZX200	0.91	Q345B	910	HD	GP TYPE
Hitachi	ZX240	1.2	Q345B+NM400	1250	HDR	ROCK TYPE
Hitachi	ZX330	1.38	Q345B+NM400	1435	HDR	ROCK TYPE
Hitachi	ZX350	1.6	Q345B+NM400	1712	HDR	ROCK TYPE
Hitachi	ZX450	2	Q345B+NM400	2550	HDR	ROCK TYPE
Hitachi	ZX870	4.5	Q345B+NM400	5000	HDR	ROCK TYPE
Hitachi	ZX1200	5.8	Q345B+NM400	6730	HDR	ROCK TYPE

JCB EXCAVATOR BUCKET



BRAND	MODEL	CAPACITY(m3)	MATERIAL	WEIGHT (KG)	TYPE	TEETH
JCB	3CX	12"	Q345B	100	HD	JCB TYPE
JCB	3CX	18"	Q345B	120	HD	JCB TYPE
JCB	3CX	24"	Q345B	150	HD	JCB TYPE
JCB	3CX	32"	Q345B	170	HD	JCB TYPE
JCB	JS200	57"	Q345B+NM400	950	HD	JCB TYPE
JCB	JCB360	1.9	Q345B+NM400	1980	HD	JCB TYPE



Hydraulic Grab

Hydraulic Grab
Add two cylinders base on the Manual Grab, cylinders control the Grab open and close. The teeth parts are hardness wear plates, can grab wood, stone, waste metal, construction waste



Dustpan Bucket

Dustpan Bucket
The shape is very wide and shallow, the bottom is flate and add wear stripes. it can be applied to marble, mine, and the other big stones load and excavation.

HARDWARE



PIN&RETAINER	Model	P/N	Description	Model	P/N	Description	Model	P/N	Description
Caterpillar	J200/E3202	8E6208	PIN	966	9J2358/9J8926/8J2189	PIN	J800	4K43	PIN
		1U4208		966	3G9549	RETAINER		4K41	RETAINER
		9W7112		J400/C325/E3402	7T3408	PIN		1U0739	PIN
		8E6209	RETAINER		1167408			1U0740	RETAINER
		4T0001			8E8409	RETAINER		5K1459	PIN
		9J4209			7Y3409			5K1458	RETAINER
J225/E305/307		6Y6228	PIN		1167409			6Y3394	PIN
		6Y3228		J450	6Y2527	PIN		3G9559	RETAINER
		1324762			1U1458			8E4743	
		8E6259	RETAINER		9W8296			6Y3909	PIN
		3G9609			4T1458			6Y1204	
		8J5309			8E6359	RETAINER		4T4707	RETAINER
		1330699			1140359			6Y1202	
		1495733			3G9549			9G1458	PIN
J250/E312		8E6258	PIN		7J6845			3G9549	RETAINER
		9J2258			6Y9549			1U2405	
		8J4258		J460/E330	8E0468	PIN	1368308	9W2668	PIN
		1324766			1140468			9J6583	
		8E6259	RETAINER		1010168			3G9549	RETAINER
		8E6260			8E8469	RETAINER			
		3G9610			8E0469				
		8J5310			1073469				
		1330700		J550/E345	6Y8558	PIN	PC60		pin & lock
		1495734			101558		PC100	20X-70-00100	pin & lock
930		9J2258	PIN		9W9026		PC120side cutter	09244-02488	pin & lock
930		3G9509	RETAINER		1073378		PC120	09244-02489	pin & lock
J300/E315/200B		9J2308	PIN		1139608		PC200	09244-02496	pin & lock
		107-3308			616609	RETAINER	PC200	205-70-74281	pin & lock
		8J5308			1139609		PC220	09244-02508	pin & lock
		1324766		J700/E385	4T4708	PIN	PC300	09244-02516	pin & lock
		8E6259	RETAINER		1134708		PC300 side cutter		pin & lock
		8E6261			4T4707	RETAINER	PC400	09244-03036	pin & lock
		3G9611			1134709		PC400side cutter		pin & lock
		8J5311		J800	1020101	PIN	PC650	209-70-54240	pin & lock
		1330701			1341808		PC1000		pin & lock
		1495735			1012874	RETAINER	PC1250	21N-72-14330	pin & lock
950		3G-9609(112-7874)	RETAINER		1341809			21N-72 14580	pin & lock
J350/E320		8E6358	PIN		4T2479	PIN	18/20S		pin
		9J2358			7J9600				lock
		9W2678			4763	PIN	25/30S		pin
		1140358			132-4766	PIN			lock
		8E6359	RETAINER		3G0500	PIN	35S	205-70-74281	pin
		3G9549						205-70-74291	lock
		7J6845					40S		pin
		1140359							lock
		6Y9450					D375-1	195-78-71360	PIN

HARDWARE



BONNETS



Fuel Injection

Part No.	Application
1W9171	3306
6I1327	3306
8S3653	3306
8N2516	3204, 3304, 3402, 3306, 3306B
8N1417	3208, 3304
4N2484	3208, 3406, 3408, 3408B, 3412
4N0209	3304, 3306, 3208
4M0411	3304, 3306, D333, D336
9L6893	3406, 3408, 3408B, 3412, 3412B
1082102	3406B, 3406C

Oil Cooler

Part No.	Application
6N0125	3304, 3306
6N0124	3304, 3306, 3306B
9L5910	3306, 3306B

Oil Cooler Transmission

Part No.	Application
7N3512	3306
8S4304	3306, 3406B, 3406C



ADAPTERS

Part No.	Description	Part No.	Description
2R8613	ADAPTER	6D6489	ADAPTER
3J7355	ADAPTER	6K3457	ADAPTER
3R2704	ADAPTER	6K6967	ADAPTER
3R5387	ADAPTER	6L9777	ADAPTER
4L8545	ADAPTER	6L9781	ADAPTER
4S6678	ADAPTER	6L9952	ADAPTER
4V6485	ADAPTER	7D4903	ADAPTER
5D9231	ADAPTER	7D5363	ADAPTER
5K6875	ADAPTER	8F0390	ADAPTER
5P1404	ADAPTER	8L3282	ADAPTER
5P2937	ADAPTER	8L6557	ADAPTER
5P3501	ADAPTER	8M0755	ADAPTER
5P5528	ADAPTER	9L4007	ADAPTER
5P6944	ADAPTER	9M6522	ADAPTER
5P9617	ADAPTER		

CONNECTORS



Part No	Description	Part No	Description
0308189	CONNECTOR	5P2949	CONNECTOR
0308194	CONNECTOR	5P4248	CONNECTOR
1P0268	CONNECTOR	5P4402	CONNECTOR
2P1289	CONNECTOR	619463	CONNECTOR
2P7636	CONNECTOR	6K3607	CONNECTOR
2R6276	CONNECTOR	6V8634	CONNECTOR
307935	CONNECTOR	6V8635	CONNECTOR
308188	CONNECTOR	6V8636	CONNECTOR
308196	CONNECTOR	6V8637	CONNECTOR
318759	CONNECTOR	6V8638	CONNECTOR
321267	CONNECTOR	6V8639	CONNECTOR
3J7352	CONNECTOR	6V8640	CONNECTOR
4S6680	CONNECTOR	6V8642	CONNECTOR
5P1046	CONNECTOR	6V8647	CONNECTOR
5P2948	CONNECTOR	6V8714	CONNECTOR

BUSHINGS



Part No.	Description
0115224	BUSHING
1H7724	BUSHING
2H5547	BUSHING
3B6768	BUSHING
3B7255	BUSHING
3B7721	BUSHING
3B7764	BUSHING

Part No.	Description
4M5317	BUSHING
5B4855	BUSHING
6B4661	BUSHING
8B1931	BUSHING
9F9920	BUSHING

COTTER PINS



Part No.
1J2919
1S0685
1S0686
2H3768
2H3771
3B4605
3B4607
3B4610
3B4611
3B4615
3B4617
3B4618
3B4621

Part No.
3B4622
3B4627
3B4629
3B4631
3B4632
3B4640
3B4643
3B5301
3B5303
3B5316
3B5317
3B5319
3B5320

DOWELS



Part No.	Part No.	Part No.	Part No.
0L2061	2M0122	4N0511	7M8480
0S0130	2M0138	4N0683	7N1902
1044746	2M4537	4N0684	7N2043
1141539	2N5775	4N0955	7N5352
1141541	2P8630	4N1650	7N5683
1155327	2S6091	4N9019	7S4326
1171801	3B2225	4S8537	7S5005
1334952	3B8852	4S8541	7T3109
1499113	3D6509	5B1980	7T5886
1A2036	3E3217	5B5812	7Y4256
1A2223	3F0011	5B5821	8B1312
1A2610	3F0957	5B7652	8B6349
1F1006	3F1526	5H3262	8H9189
1F5151	3F1953	5M3605	8H9208
1F5546	3F3442	5M4606	8K0589
1H0525	3F4746	5M4987	8K6630
1H0974	3F6795	5M7937	8M6521
1M4291	3F8283	5S4033	8M8659
1M5156	3H0703	5S4441	8S3426
1S5440	3H4174	6F0698	8S6814
1S6249	3N2712	6F4161	8T0099
1S7558	3P1681	6F7172	9C6041
1S9292	3P7832	6K5614	9G0832
1S9540	4B8265	6M9155	9H4105
2194458	4D0537	6T5545	9H5546
2390689	4D6472	6V2452	9M0669
2A3348	4F6154	6V3536	9M2001
2A3630	4F6165	6V3537	9M4007
2A3798	4H0254	6V3538	9P7751
2B8162	4H6534	6V3539	9P7752
2D0874	4K7239	7B5415	9W1741
2H1190	4L3395	7M1201	
2H2255	4M3122	7M8479	